



INTRODUCTION

R-Vent Medikal was founded in 2015 with confidence and value. Located in Izmir, Turkey, R-Vent is a professional enterprise in the field of researching, manufacturing, marketing and servicing disposable medical devices. We provide flexible patient solutions for airway management, anesthesia, critical care and oxygen & aerosol therapy for use within emergency care, the hospital environment and also in the home. All products have been clinically tested. A dynamic and inventive company, R-Vent enjoys international success via export to Europe, North and South America, Asia, Africa and Australia continents, growing up with the warmest welcome by its devoted customers.

Biocompatible raw materials used in production are in conformity to USP and ISO 10993 Standards. In-house acceptance controls are also performed to meet the stringent demands of our quality system. Extrusion, injection and blow molding processes are performed in controlled environments. Product assembly and packaging are performed in class 10.000 and 100.000 clean rooms. Disposable medical devices are packaged in clean rooms using fully automated equipment with validated processes and packaging materials. Our goal is to continually supply high quality medical devices to healthcare professionals all over the world and to ensure that these products fully comply to both national and international regulatory and customer requirements. All products bear the CE mark demonstrating compliance with the Medical Device Directive 93/42/EEC. R-Vent Quality Management System is certified according to ISO 13485:2016.

A specialist in Anesthesiology, R-Vent aims to extend its product range over the time. R-Vent commits to Research and Development of new products while aiming to be at the forefront of advancements in anesthesiology.

R-Vent proudly stands for its ability to serve you with OEM and ODM services which assist you to find the best product that accommodates your unique requirement. We are dedicated to supply high quality components tailored to individual customer requirements. In the core of business, all staff holds the same belief: We care for patients with quality products. The company runs many projects with world-wide multinationals.

R-Vent products, services and activities have an environmental dimension. We follow a sustainable development policy in line with the move to a cleaner and healthier world for future generations. We strive to protect and improve healthcare and welfare of the humanity.



OUR MISSION

Our mission is to become a distinguished company which produces and supplies reliable, high class, cost - effective, affordable medical products for the improvement in the quality of human life.

OUR VISION

We are dedicated to be admired by both our customers and partners all around the world for the best quality of our products and services. We not only aim to be good in healthcare, but also in welfare of all humanity.

We suggest; **TAKE A NEW BREATH WITH RVENT**

CORE VALUES

- Prosperity of humanity
 - Honesty
 - Leadership
 - Teamwork
- Customer orientation
 - Innovation
 - Dynamism
 - Creativity
 - Sustainability
- Continuous development

QUALITY POLICY

Our quality policy in R-Vent Medikal is;

- To be an innovative and leading company in medical device industry
- To provide the market with competitive prices without compromising product quality and our core values
- To keep customer satisfaction at utmost level
- To comply with ISO & FDA Standards
- To improve product quality by implementation of international standards
- To ensure that each employee in the organization adopts the same vision, mission and core values

ENVIRONMENTAL, HEALTH AND SAFETY POLICY

R-Vent Medikal dedicates itself to the welfare of humanity. Company has social responsibility concerning environmental, health and safety issues. We assure;

- To implement environmental, health and safety practices in work environments and for our employees
- To use energy sources efficiently
- To conserve natural resources and minimize the waste
- To inform and raise awareness among all our employees
- To operate all company facilities in compliance with environmental legislations

A GUIDE TO OUR CONNECTORS

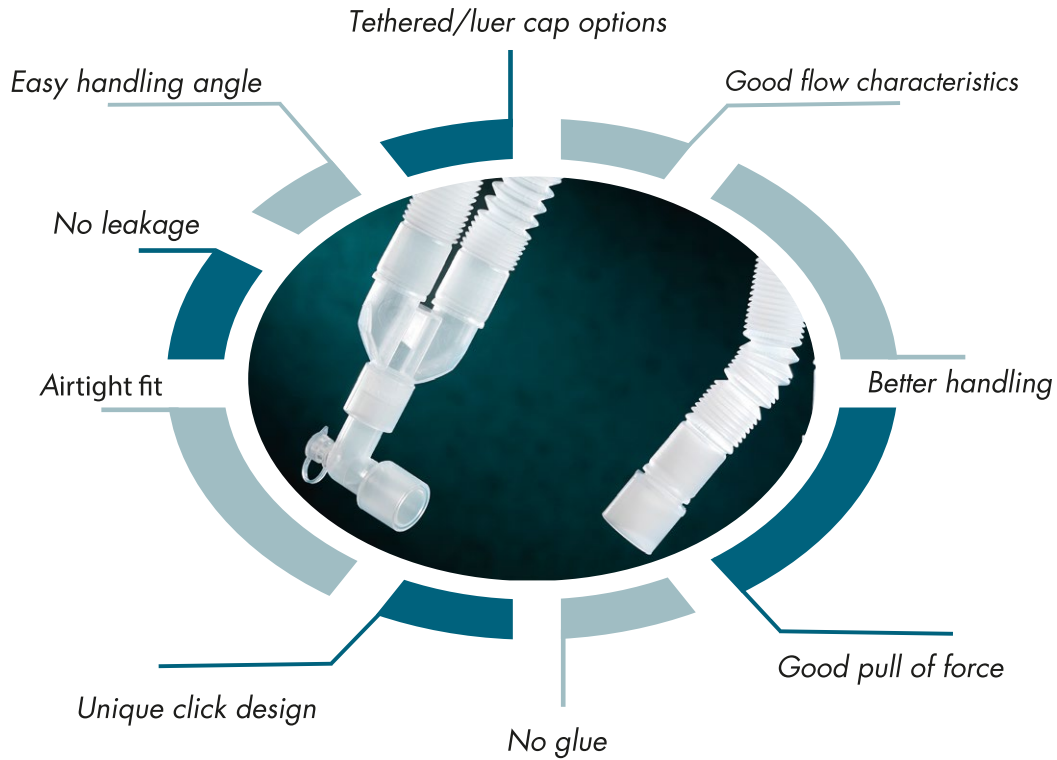

A GUIDE TO OUR WATERTRAPS

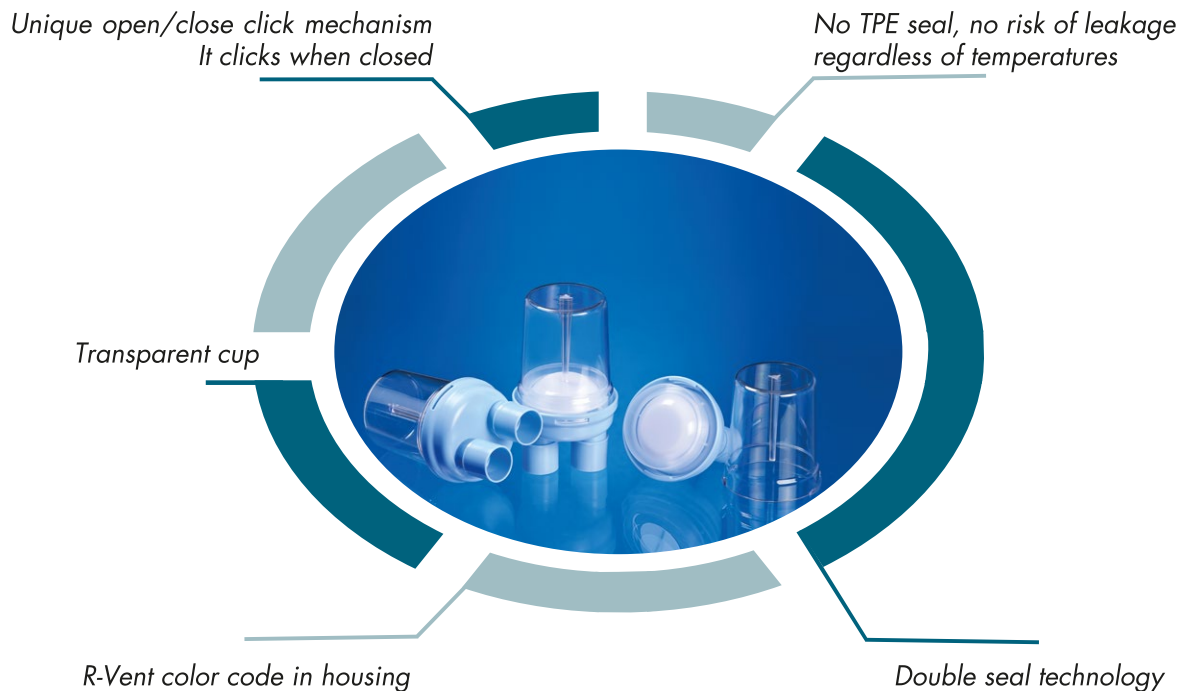

A GUIDE TO OUR TUBINGS

Low risk of leakage
with tight notch connections

Minimum condensation
build-up in the circuit

Crush-proof thereby eliminating any
risk of ventilation being interrupted

Less bacterial growth

Lower kinking risk

Available in all colours



Corrugated Tubings

- Light weight and economical system
- Corrugated inside
- Flexible, elastic within the tube
- 4 different sizes; 26mm, 22mm, 15mm, 10mm
- Raw material PE

Extendible Tubings

- Easy positioning for convenient usage and storage
- Corrugated and expandable
- Ability to store a memory, easy set-up for further usages
- 2 different sizes; 22mm, 15mm
- Raw material PP

Smoothbore Tubings

- Reinforced by an external helix while inner surface is smooth
- Low flow resistance
- No water accumulation
- Low compliance
- 2 different sizes; 19 mm, 15mm
- Raw material PVC
- PHT and DEHP Free

A GUIDE TO OUR CATHETER MOUNTS

Smoothbore, extendible, corrugated versions

Transparent, clear to see

R-Vent color code in ports for easy observation

Low compliance

Good flow characteristics

Red safety cap option

Phtalate- Latex Free

Unique design with no leakage, easily rotating swivel ports

Sterile/ Nonsterile options

*Bronchoscopy and suction ports
first tab open → bronchoscope mode with seal
second full cap open → suction mode*

A GUIDE TO OUR FILTERS

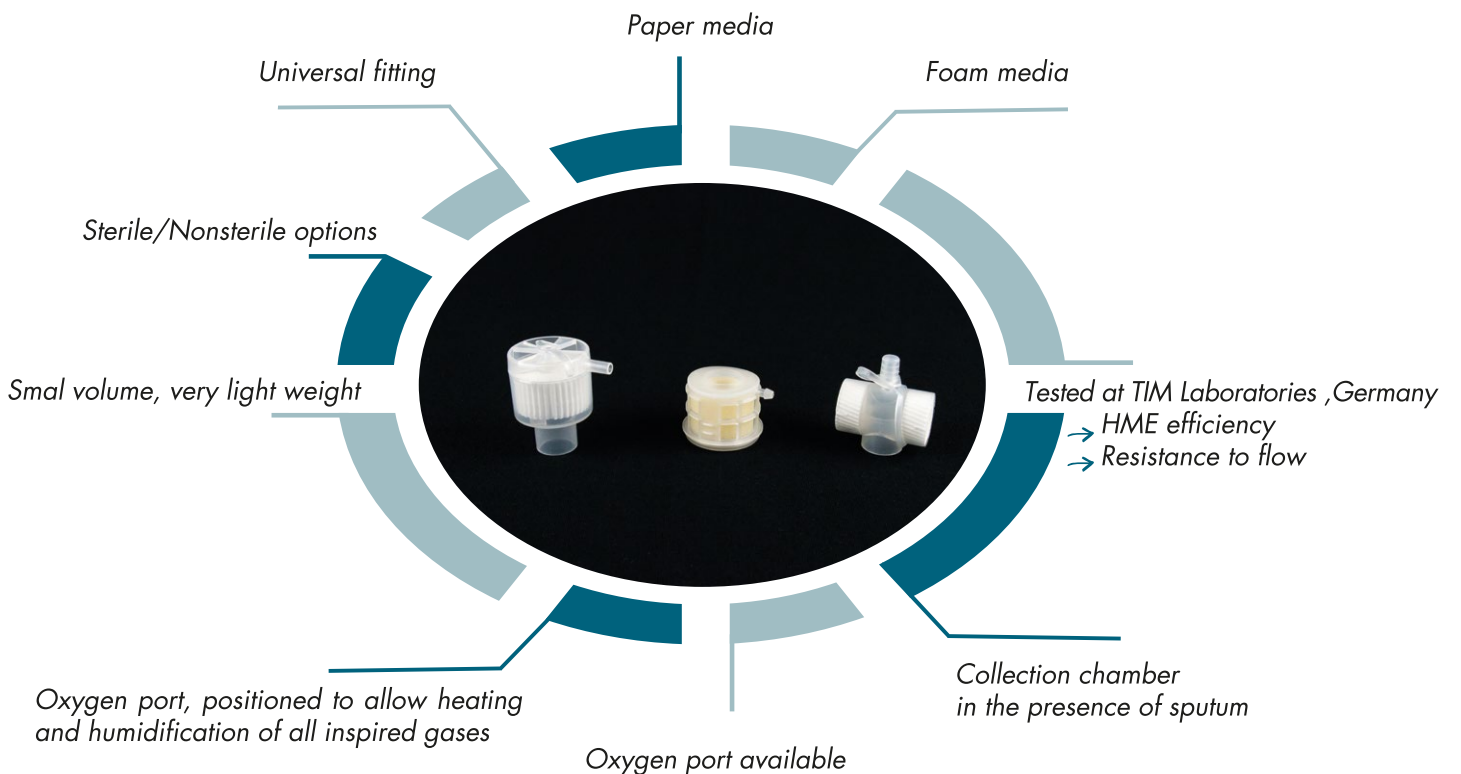
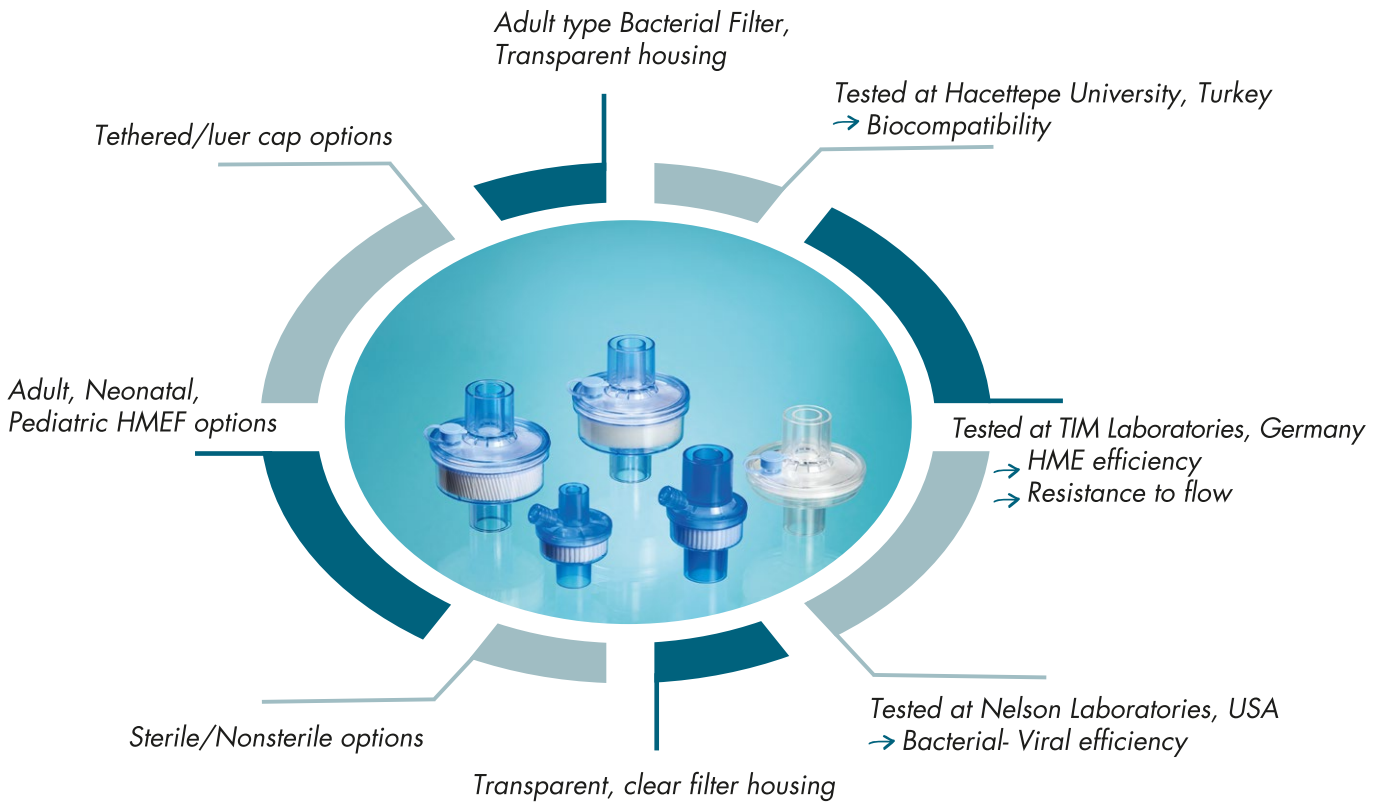

RVENT



INDEX

- 09** *Anesthesia Circuits*
- 15** *Semi-Closed Circuits*
- 16** *Ventilation Circuits*
- 18** *IPPB & Home Care Circuits*
- 21** *Special Circuits*
- 23** *Circuits For Trilogy Philips
Respironics®*
- 25** *Heated Wire Circuits*
- 26** *Neonatal Circuits*
- 27** *Humidifier Chamber*
- 28** *CPAP Circuits*
- 29** *BPAP Circuits*
- 30** *Catheter Mount*
- 33** *Filters*
- 36** *Gas Sampling Lines*
- 37** *Closed Suction Systems*
- 39** *Oxygen & Aerosol Therapy*
- 41** *BVM Resuscitators*
- 44** *Masks*
- 47** *Accessories*
- 48** *Connectors*
- 52** *Tubings*

**TAKE A NEW BREATH
WITH R-VENT**

ANESTHESIA CIRCUITS

- Successful notch design eliminates the risk of disconnection and leakage in the circuits
- All circuit types can be customized. R-Vent has the capacity of customization which provide end-users with an endless number of disposable breathing circuit configurations.
- All circuits are manufactured in 10.000 class clean room.
- The products are CE marked and comply with ISO 13485: 2016 quality regulation.
- All circuits are made of medical grade material.
- Sterile option available



Anesthesia Circuits

Corrugated	Length	Code	Qty/Box
Adult	160 cm/~63"	11004000	40
Pediatric	160 cm/~63"	41004000	60

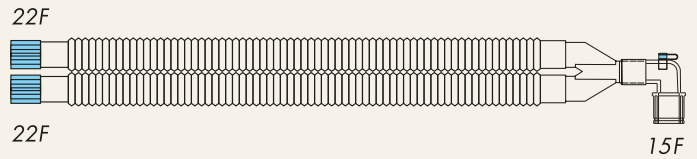

Extendible	Length	Code	Qty/Box
Adult	180 cm/~71"	31005000	100
Pediatric	150 cm/~59"	61003000	100

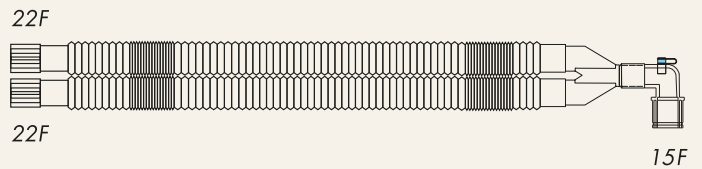

Smoothbore	Length	Code	Qty/Box
Adult	180 cm/~71"	21005000	40
Pediatric	150 cm/~59"	51003000	50

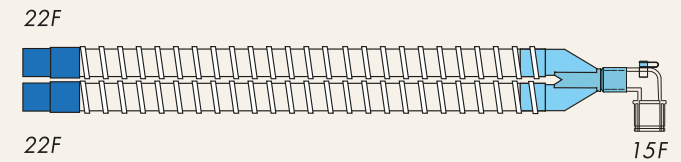

Anesthesia Circuits with Limb, Latex Breathing Bag

Corrugated	Length	Code	Qty/Box
Adult	160 cm/~63"	11104010	30
Pediatric	160 cm/~63"	41104010	50

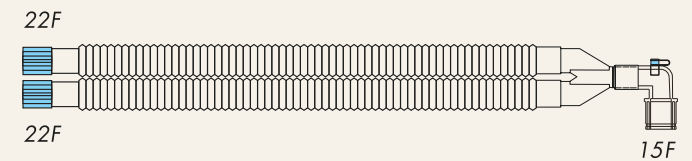

Extendible	Length	Code	Qty/Box
Adult	180 cm/~71"	31305010	70
Pediatric	150 cm/~59"	61303010	70

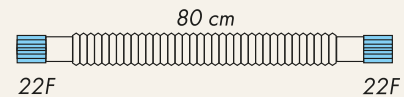

Smooth Bore	Length	Code	Qty/Box
Adult	180 cm/~71"	21205010	30
Pediatric	150 cm/~59"	51203010	40

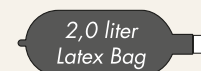
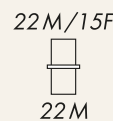

Corrugated Tubing Circuits

- Light weight and economical system
- Low risk of leakage with tight notch connections

Extendible Tubing Circuits

- Easy positioning for convenient usage and storage
- Low risk of leakage with tight notch connections
- Ability to store a memory, easy set-up for further usages

Smoothbore Tubing Circuits

- Better compliance
- Lower kinking risk
- Minimum condensation build-up in the circuit
- Less bacterial growth
- Reinforced by an external helix while inner surface is smooth
- Crush-proof thereby eliminating any risk of ventilation being interrupted

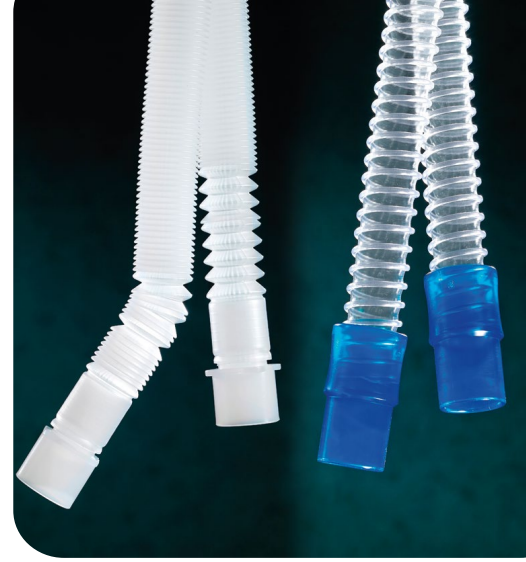

• Anesthesia Circuits with Limb, Latex-Free Breathing Bag

Corrugated	Length	Code	Qty/Box
Adult	160 cm/~63"	11104020	30
Pediatric	160 cm/~63"	41104020	50

Extendible	Length	Code	Qty/Box
Adult	180 cm/~71"	31305020	70
Pediatric	150 cm/~59"	61303020	70

Smooth Bore	Length	Code	Qty/Box
Adult	180 cm/~71"	21205020	30
Pediatric	150 cm/~59"	51203020	40

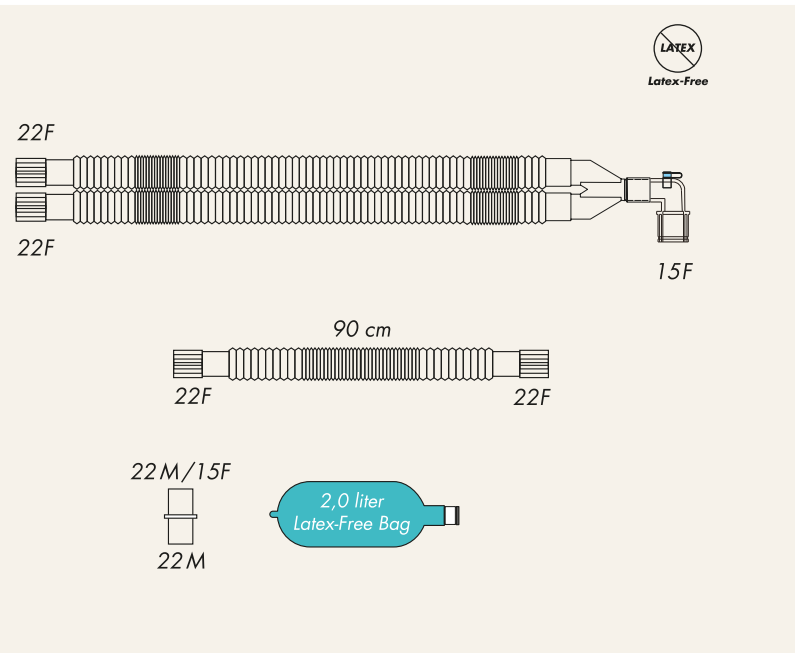

• Anesthesia Circuits with Limb, Latex Breathing Bag, Bacterial-Viral Filter

Corrugated	Length	Code	Qty/Box
Adult	160 cm/~63"	11104110	30
Pediatric	160 cm/~63"	41104110	50

Extendible	Length	Code	Qty/Box
Adult	180 cm/~71"	31305110	60
Pediatric	150 cm/~59"	61303110	70

Smooth Bore	Length	Code	Qty/Box
Adult	180 cm/~71"	21205110	30
Pediatric	150 cm/~59"	51203110	30

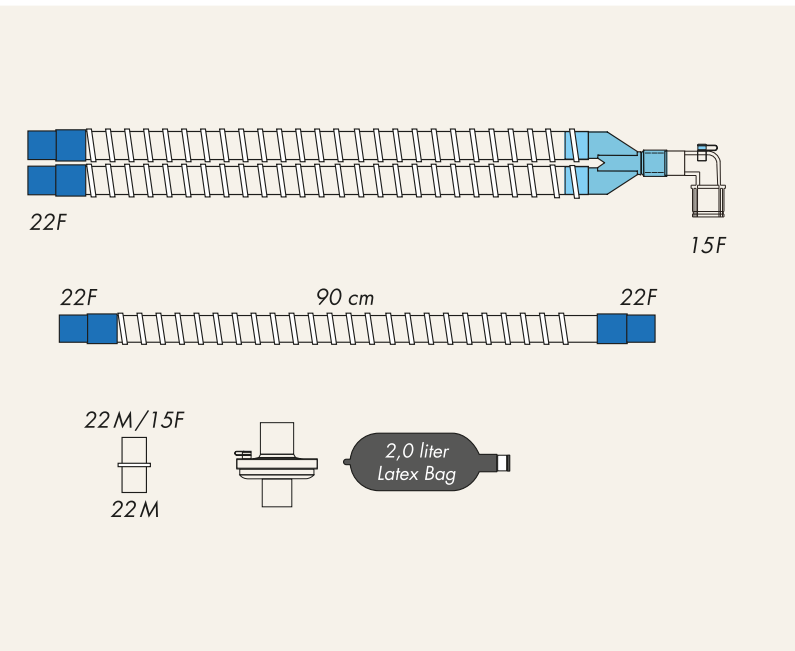

Anesthesia Circuits with Limb, Latex-Free Breathing Bag, Bacterial-Viral Filter

Corrugated	Length	Code	Qty/Box
Adult	160 cm/~63"	11104120	30
Pediatric	160 cm/~63"	41104120	50

Extendible	Length	Code	Qty/Box
Adult	180 cm/~71"	31305120	60
Pediatric	150 cm/~59"	61303120	70

Smooth Bore	Length	Code	Qty/Box
Adult	180 cm/~71"	21205120	30
Pediatric	150 cm/~59"	51203120	30

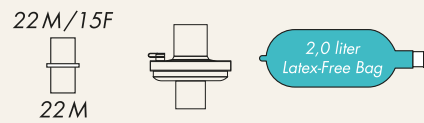
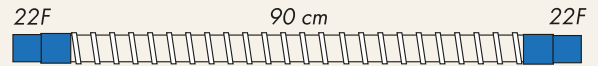
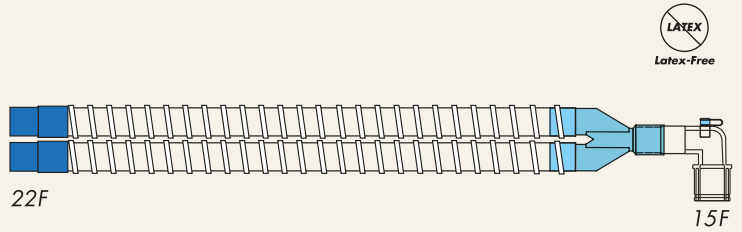

Datex ADU® Anesthesia Circuits

Corrugated	Length	Code	Qty/Box
Adult	160 cm/~63"	11104019	30
Pediatric	160 cm/~63"	41104019	40

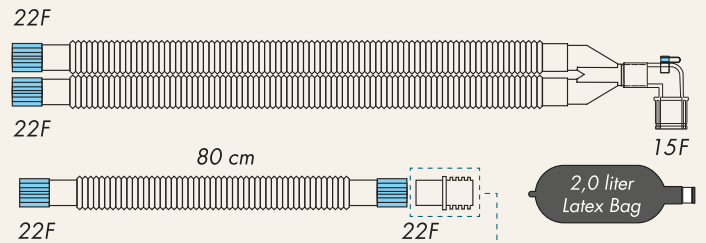

Limb is fitted with a special straight connector at this machine

For use with Datex ADU®

GE® Workstations Anesthesia Circuits

Corrugated	Length	Code	Qty/Box
Adult	160 cm/~63"	11104020-5	30
Pediatric	160 cm/~63"	41104020-5	50

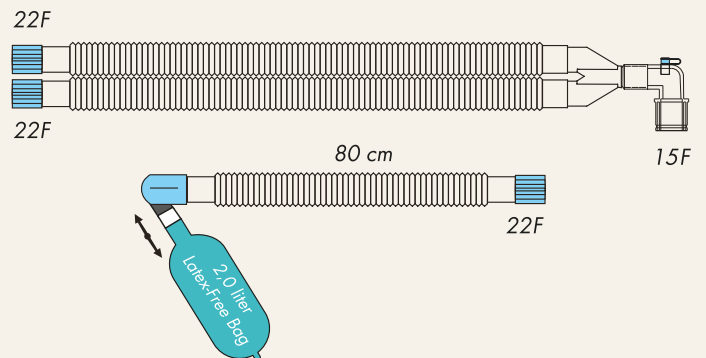

For Use with GE® Workstations

Double Gas Sampling Line Circuits

- The circuit has a healthy and cost-effective design
- The circuit decreases the use of anesthetic volatile agent by returning the gas to the system, by doing, it maintains the gas in the system and prevents operating people from inhaling volatile gas which is not in the atmosphere thanks to circuit design



Anesthesia Circuits with Limb, Latex Breathing Bag, Bacterial-Viral Filter, Gas Sampling Line

Smooth bore

	Length	Code	Qty/Box
Adult	180 cm/~71"	21205114	30
Pediatric	150 cm/~59"	51203114	30

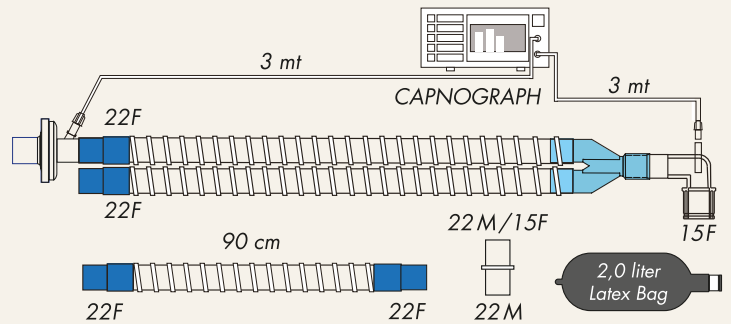

Anesthesia Circuit with Breathing Bag, Anesthesia Mask, Bacterial-Viral/HME Filter, Gas Sampling Line

Corrugated

	Length	Code	Qty/Box
Adult	160 cm/~63"	11004154	30

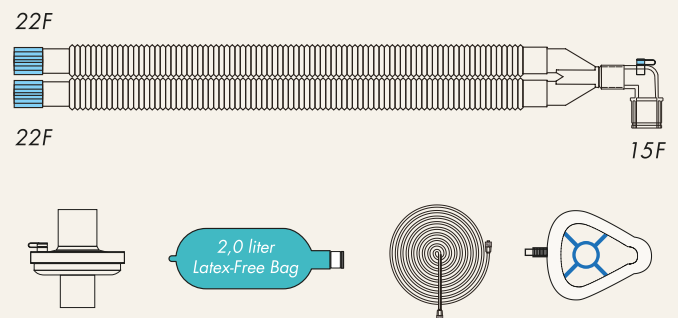



Coaxial Circuits

- Simple and qualified functional design of streamlined tubing within a tube
- The design enables elimination of twisting between inspiratory and expiratory limbs
- The circuit offers a better chance of mobility and practical usage
- Inspired gasses become warm and humidified when exhaled through expiratory tubings, which result in self-contained and thermally sufficient atmosphere

Duo-Limb Circuit

- Less weight than two-limb circuits
- Reduced torque on patient's airway
- More versatility when used as a transport circuit
- Kinking resistant, high quality

Coaxial Circuits With Extendible Limb

Corrugated	Length	Code	Qty/Box
Adult	180 cm/~71"	99005000	40
Pediatric	140 cm/~55"	09009000	40

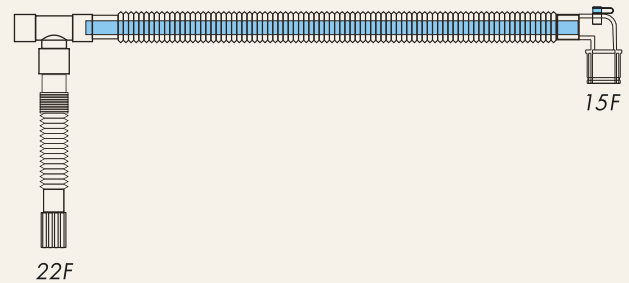

Coaxial Circuits With Extendible Limb, Latex Breathing Bag

Corrugated	Length	Code	Qty/Box
Adult	180 cm/~71"	99305010	30
Pediatric	140 cm/~55"	09309010	30

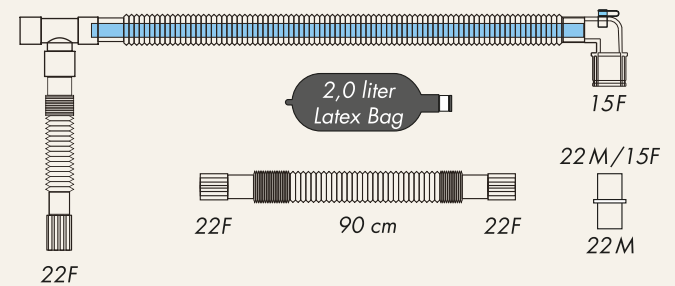

Coaxial Circuits With Extendible Limb, Latex-Free Breathing Bag

Corrugated	Length	Code	Qty/Box
Adult	180 cm/~71"	99305020	30
Pediatric	140 cm/~55"	09309020	30

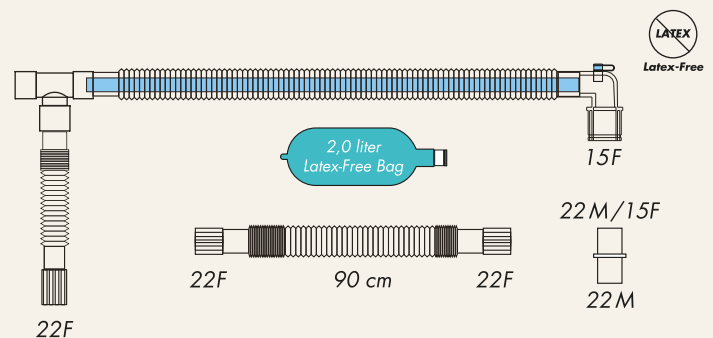

Coaxial Circuits With Extendible Limb, Latex Breathing Bag, Bacterial-Viral Filter

Corrugated

	Length	Code	Qty/Box
Adult	180 cm/~71"	99305110	30
Pediatric	140 cm/~55"	09309110	30

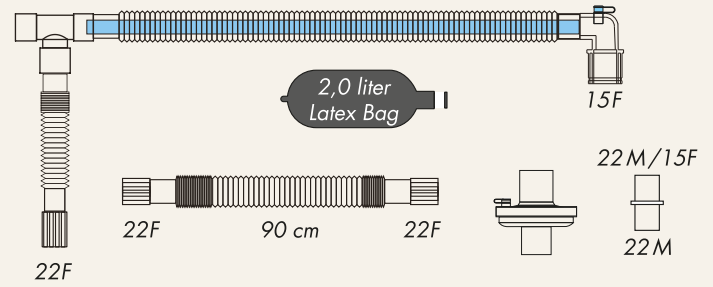

Coaxial Circuits With Extendible Limb, Latex-Free Breathing Bag, Bacterial-Viral Filter

Corrugated

	Length	Code	Qty/Box
Adult	180 cm/~71"	99305120	30
Pediatric	140 cm/~55"	09309120	30

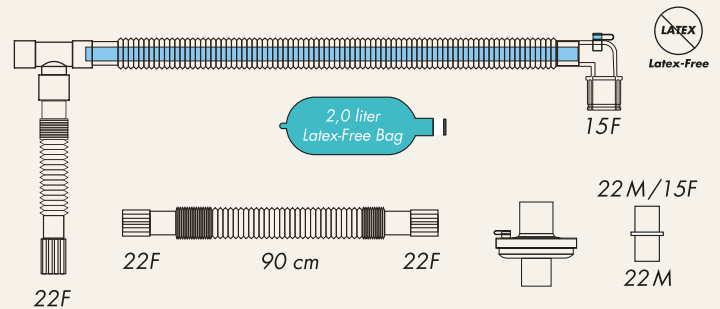

Coaxial Circuits With Extendible Limb, Latex Breathing Bag, Bacterial-Viral Filter, Gas Sampling Line

Corrugated

	Length	Code	Qty/Box
Adult	180 cm/~71"	99305114	30
Pediatric	140 cm/~55"	09309114	30

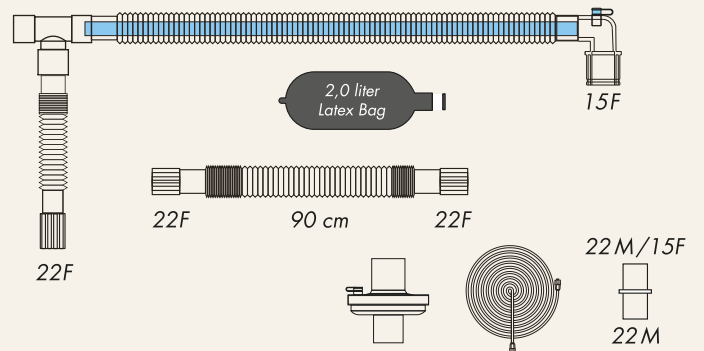

Duo-Limb Circuit

Corrugated

	Length	Code	Qty/Box
Adult	180 cm/~71"	99105000	40

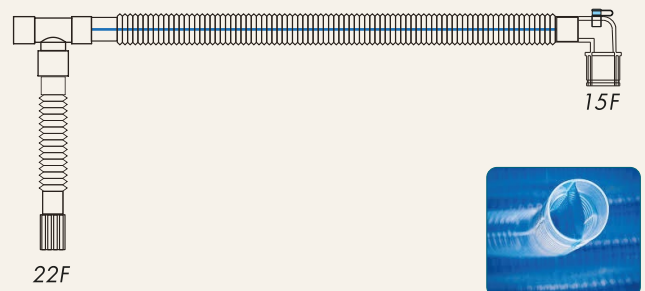

SEMI-CLOSED CIRCUITS



Modified Jackson Rees Circuits Fresh Gas Line, Washington Tee, Tail Bleed Valve With Breathing Bag

Corrugated	Length	Code	Qty/Box
Adult	140 cm/~55"	901	50
Pediatric	140 cm/~55"	902	50

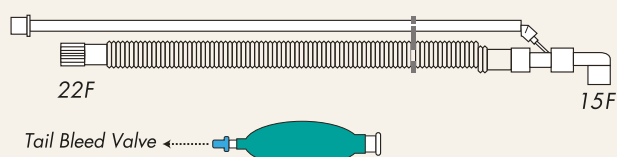

Bain Circuits Standard 1/4" Barbed Fresh Gas Connector With Breathing Bag

Corrugated	Length	Code	Qty/Box
Adult	140 cm/~55"	903	50
Pediatric	160 cm/~63"	904	50

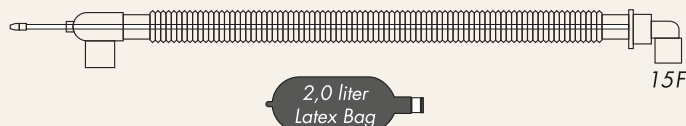

Mapleson D-Deluxe Bain Circuit

Corrugated	Length	Code	Qty/Box
Adult	140 cm/~55"	905	30

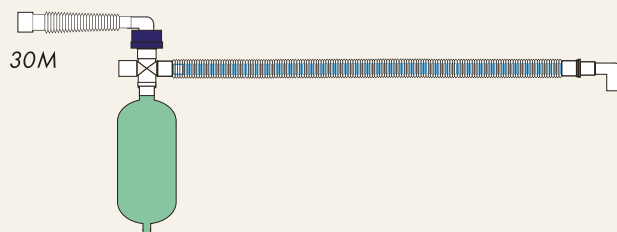

Mapleson A Circuit

Corrugated	Length	Code	Qty/Box
Adult	140 cm/~55"	906	30

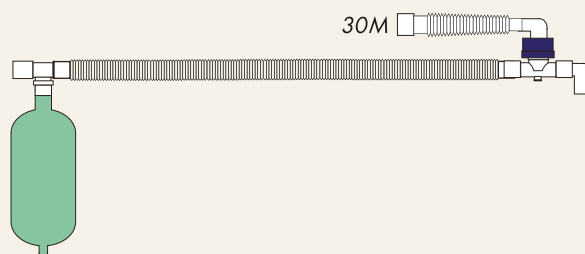

Mapleson C Circuit

Corrugated	Length	Code	Qty/Box
Adult	110 cm/~43"	907	30



VENTILATION CIRCUITS

- Successful notch design eliminates the risk of disconnection and leakage in the circuits
- All circuit types can be customized.
- R-Vent has the capacity of customization which provide end-users with an endless number of disposable breathing circuit configurations.
- All circuits are manufactured in 10.000 class clean room.
- The products are CE marked and comply with ISO 13485: 2016 quality regulation.
- Specially used in intensive care units
- Sterile option available



• Ventilation Circuits

Corrugated

	Length	Code	Qty/Box
Adult	160 cm/~63"	12004000	40
Pediatric	160 cm/~63"	42004000	50

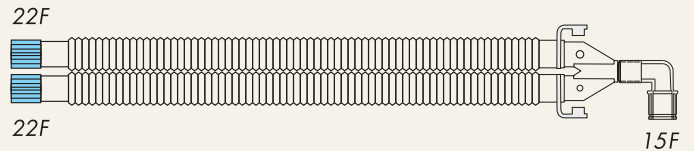

Smoothbore

	Length	Code	Qty/Box
Adult	180 cm/~71"	22005000	40
Pediatric	150 cm/~59"	52003000	50

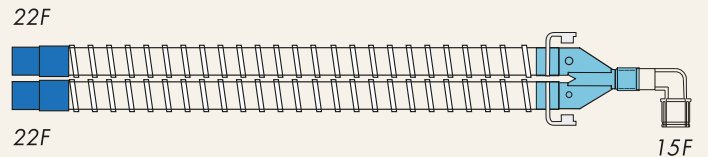

• Ventilation Circuits With Limb, Single Water Trap

Corrugated

	Length	Code	Qty/Box
Adult	160 cm/~63"	12114000	30
Pediatric	160 cm/~63"	42114000	40

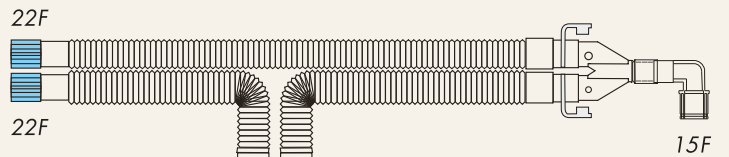

Smooth Bore

	Length	Code	Qty/Box
Adult	180 cm/~71"	22215000	30
Pediatric	150 cm/~59"	52213000	40

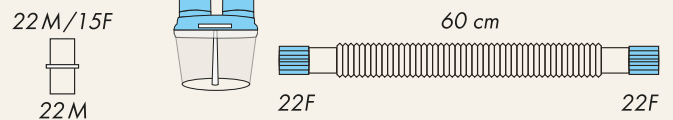



• Ventilation Circuits With Limb For Non-Active Humidification

Corrugated	Length	Code	Qty/Box
Adult	160 cm/~63"	12124000	30
Pediatric	160 cm/~63"	42124000	40

Smooth Bore	Length	Code	Qty/Box
Adult	180 cm/~71"	22225000	30
Pediatric	150 cm/~59"	52223000	40

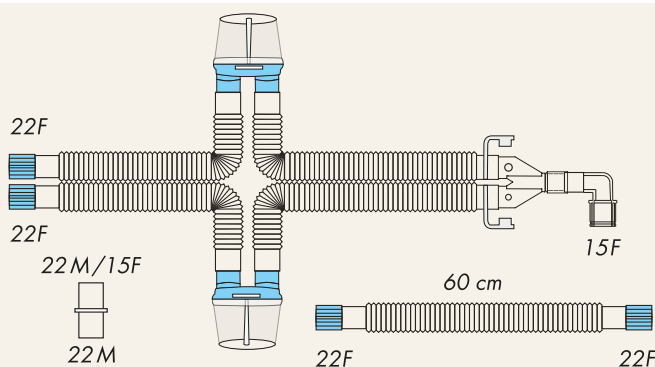

• Ventilation Circuits With Limb, Catheter Mount, Bacterial Viral/HME Filter

Corrugated	Length	Code	Qty/Box
Adult	160 cm/~63"	12124208	30
Pediatric	160 cm/~63"	42124208	30

Smooth Bore	Length	Code	Qty/Box
Adult	180 cm/~71"	22225208	30
Pediatric	150 cm/~59"	52223208	40

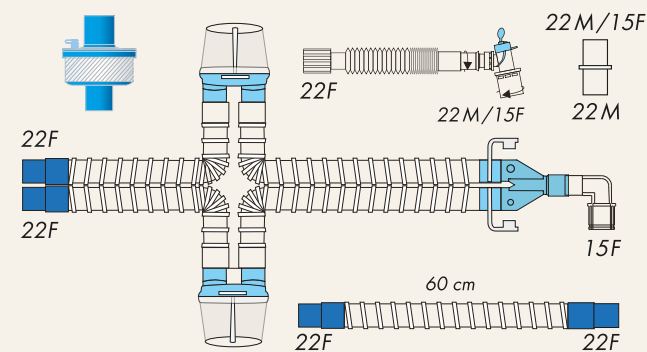

• Ventilation Circuits With Limb, Nebulizer

Corrugated	Length	Code	Qty/Box
Adult	160 cm/~63"	12124009	25
Pediatric	160 cm/~63"	42124009-1	25

Smooth Bore	Length	Code	Qty/Box
Adult	180 cm/~71"	22225009-1	25
Pediatric	150 cm/~59"	52223009-1	25

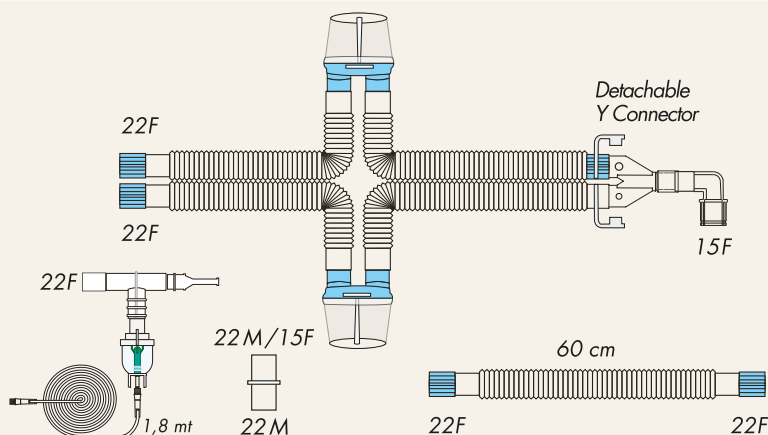

IPPB & HOME CARE CIRCUITS



- Compatible with all IPPB transport ventilators
- The products are CE marked and comply with ISO 13485: 2016 quality regulation.
- Available with different accessories such catheter mounts, mouth piece and nebulizer.

• IPPB Transport Ventilator Circuits

Corrugated	Length	Code	Qty/Box
Adult	160 cm/~63"	10004006-5	40

Smooth Bore	Length	Code	Qty/Box
Adult	180 cm/~71"	20005006-7	50

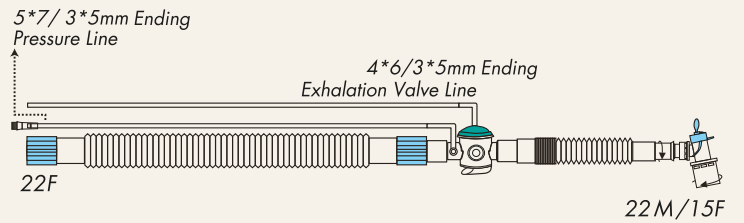

Corrugated	Length	Code	Qty/Box
Adult	160 cm/~63"	10004006-1	15

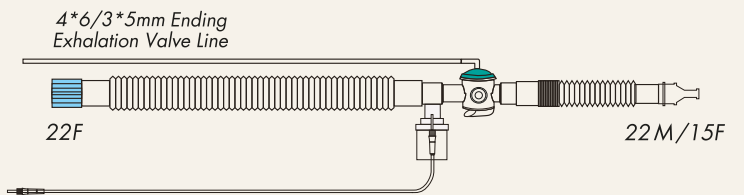



- R-Vent breathing systems for homecare ventilators include both single and dual limb circuits
- The circuits can fit to any homecare ventilator
- We also offer systems with heated wire

• Newport® HT50 Ventilator Circuit

Corrugated	Length	Code	Qty/Box
Adult	160 cm/~63"	13114007	30
Pediatric	160 cm/~63"	43114007	30

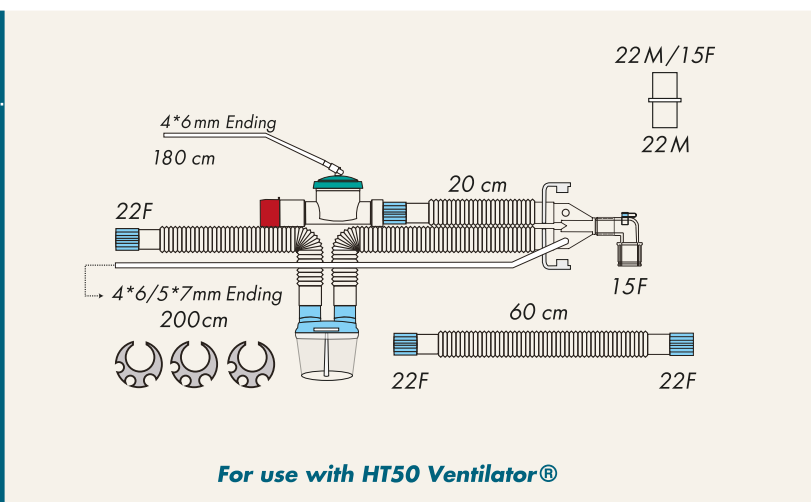

• Legend Air® Ventilator Circuit

Corrugated	Length	Code	Qty/Box
Adult	160 cm/~63"	10004006	50

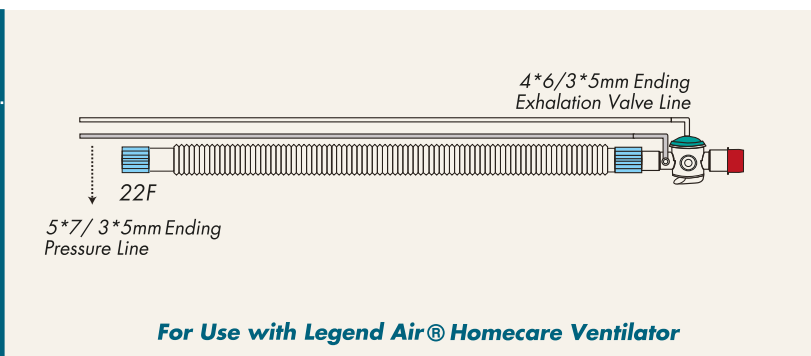

• **Covidien Legend Air® PB560, Saime Ultra V/S®, Resmed Elisee® 150 Ultra, Eole™, Helia™, VSIII®, VS Integra®, Respironics® and Trilogy™ 100 Ventilator Circuit**

Smooth Bore	Length	Code	Qty/Box
Adult	180 cm/~71"	20005006	50

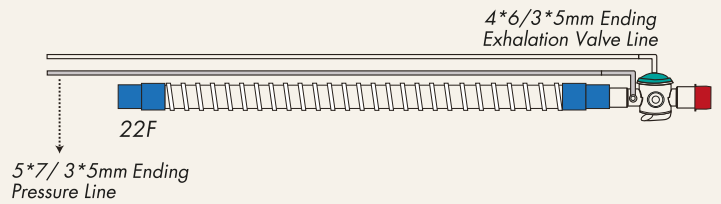

For Use with Covidien Legend Air® PB560, Saime Ultra V/S®, Resmed Elisee® 150 Ultra, Eole™, Helia™, VSIII®, VS Integra®, Respironics® and Trilogy™ 100 Homecare Ventilator

- Trilogy is registered trademark of Phillips Respironics®
- Ultra V/S, Elisee, Eole, Helia, VSIII, VS Integra are registered trademark of Resmed®

• **Air Liquide® Monnal T50®, Breas® Vivo 50™ Ventilator Circuit**

Smooth Bore	Length	Code	Qty/Box
Adult	180 cm/~71"	20005006-5	50

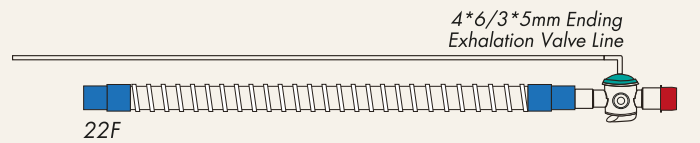

For Use with Air Liquide® Monnal T50®, Breas® Vivo 50™

- Vivo 50 is registered trademark of Breas®

SPECIAL CIRCUITS

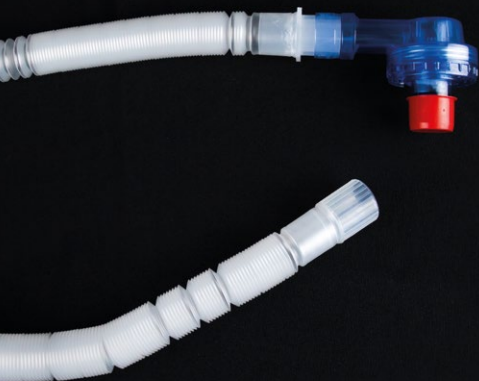

Smiths Pneupac[®], ParaPAC[®], VentiPAC[®] and TransPAC[™] Ventilator Circuit

Extendible	Length	Code	Qty/Box
Adult	180 cm/~71"	30005009	100
Adult	180 cm/~71"	30005009-1 (with peep-valve)	100

Smooth Bore	Length	Code	Qty/Box
Adult	120 cm/~47"	20002009	60
Adult	120 cm/~47"	20002009-1 (with peep-valve)	60

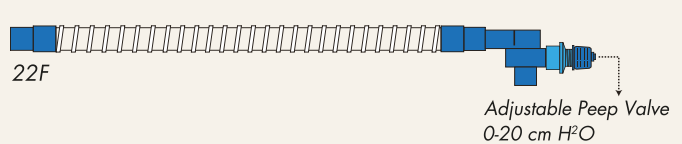

For Use with Pneupac[®] Ventilators

- Clear material
- PEEP valve option
- No risk of miss-assembly after cleaning

- No risk of contamination between patients due to inadequate cleaning
- Compatible with all- existing Pneupac ventilators
- Delivers high- efficiency oxygen therapies in pre- hospital, transport and hospital settings

Philips Cough Assist T70[®] Ventilator Circuit

Smooth Bore	Length	Code	Qty/Box
Adult	180 cm/~71"	20005130	40

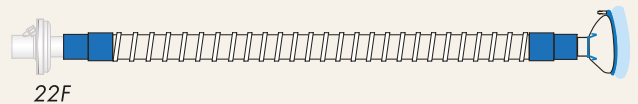

For Use with Cough Assist T70[®] Ventilators

- Clears secretion from the lungs by applying positive air pressure

Proximal Pressure Line Circuits With Limb, Humidifier Chamber

Smooth Bore	Length	Code	Qty/Box
Adult	180 cm/~71"	23215009	25
Pediatric	150 cm/~59"	53213009	30

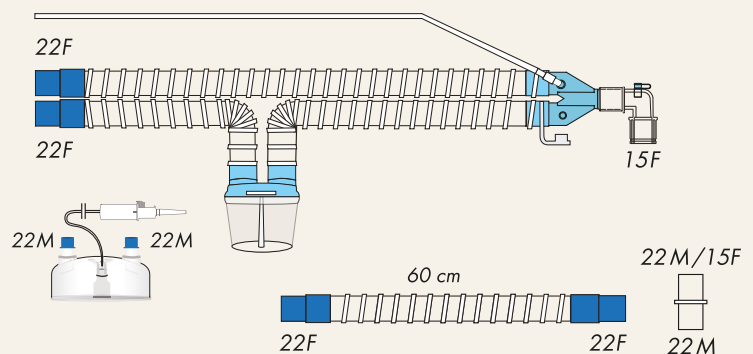

- Pneupac, TransPAC, VentiPAC, ParaPAC are trademark of Smiths Medical

Neonatal Resuscitation Circuit

- NeoVent resuscitation system includes accurate and tactile PEEP control. It has been connected with 10F/15M and 15F connections to comply with all type of machines
- NeoVent can be supplied with face masks, O2 tubing
- Red Safety Cap - Protects when not being used. Used to seal circuit for leak testing. Aids in setting of PEEP and PIP
- Customisation is available
- Different lengths available
- Enhanced PEEP Control
- Can be supplied with mask

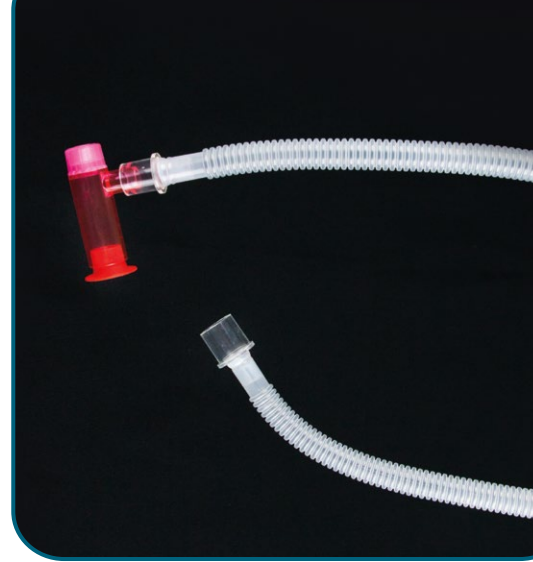

Corrugated

	Length	Code	Qty/Box
Neonatal	120 cm/~47"	70002009-1	30

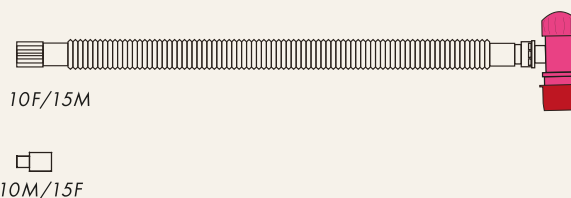

Nitrous Oxide And Oxygen Delivery Circuit

- Entonox® is a medical gas made up of equal parts of Nitrous Oxide and Oxygen. Although used mainly in childbirth, its analgesic and sedative effects are used in other hospital settings such as fracture clinics
- Our Entonox® product range includes ready to use Entonox® circuits, which use lightweight corrugated tubing and can be fitted with breathing filters and either a mouthpiece or face mask to suit patient preference

Extendible

	Length	Code	Qty/Box
Adult	300 cm/~118"	30008109	50

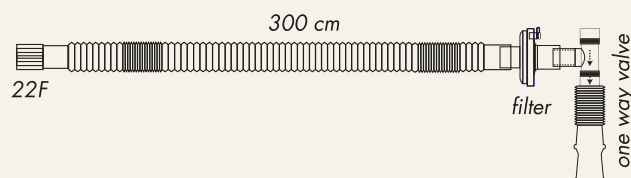



CIRCUITS FOR TRILOGY PHILIPS RESPIRONICS®

- Reliable, convenient and designed for safety
- Part of a solution; light, versatile, easy to use
- Compatible with Trilogy Philips Respironics®
- Contribute to efficiency of patient care
- Single patient use in home and care sites
- DEHP and latex free
- Prevents costly cross contamination

Circuits For Trilogy Philips Respironics®

Smooth Bore	Length	Code	Qty/Box
Adult	180 cm/-71"	29005006-1	30

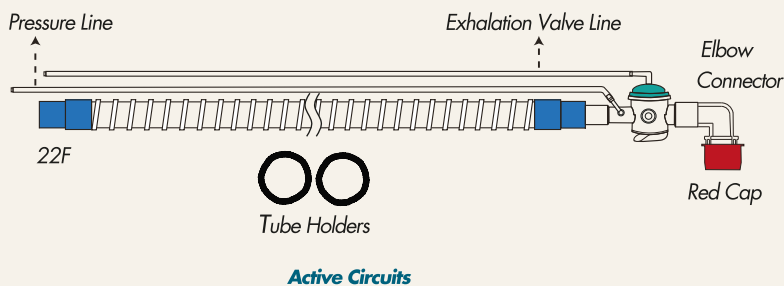

Smooth Bore	Length	Code	Qty/Box
Pediatric	120 cm/-47"	59212006-1	30

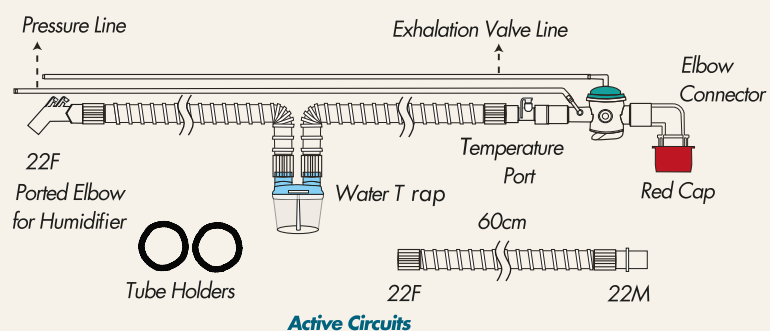

Smooth Bore	Length	Code	Qty/Box
Adult	120 cm/-47"	29212000-1	30

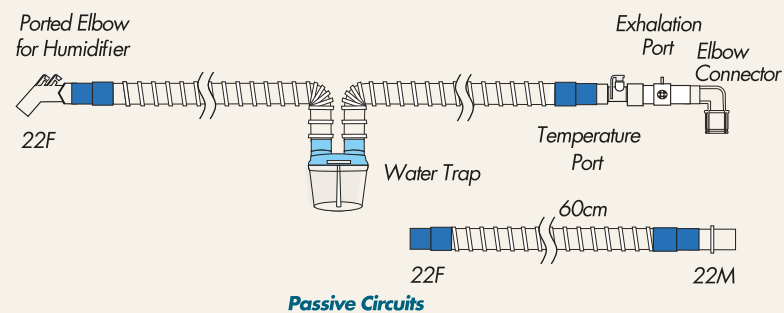

Smooth Bore	Length	Code	Qty/Box
Pediatric	120 cm/-47"	50212000-1	30

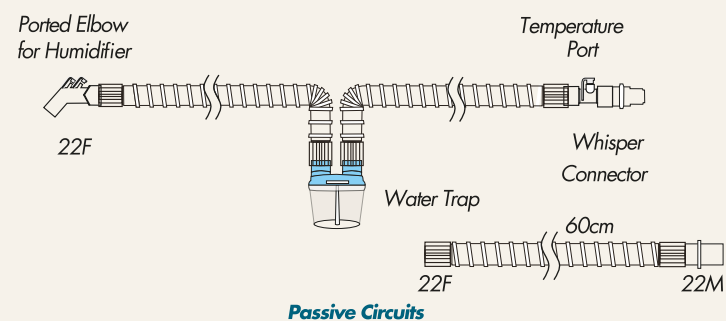

•Trilogy® is registered trademark of Philips Respironics®

CIRCUITS FOR BIO-MED DEVICES®

- Reliable, convenient and designed for safety
- Part of a solution; light, versatile, easy to use
- Compatible with Bio-med Devices®
- Contribute to efficiency of patient care
- Single patient use in home and care sites
- DEHP and latex free
- Prevents costly cross contamination



Circuits For Bio-Med Devices®

Corrugated

	Length	Code	Qty/Box
Neonatal	120 cm/~47"	75002006-1	30

Exhalation Valve Line

4*6 / 3*5

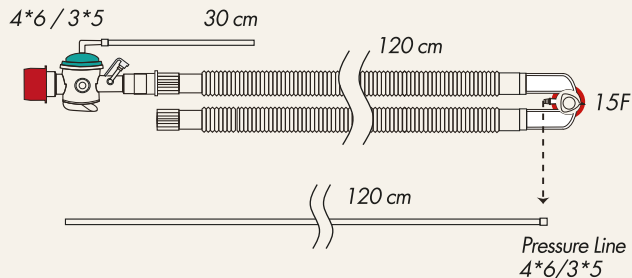

Corrugated

	Length	Code	Qty/Box
Neonatal	180 cm/~71"	75005006-1	30

Exhalation Valve Line

4*6 / 3*5

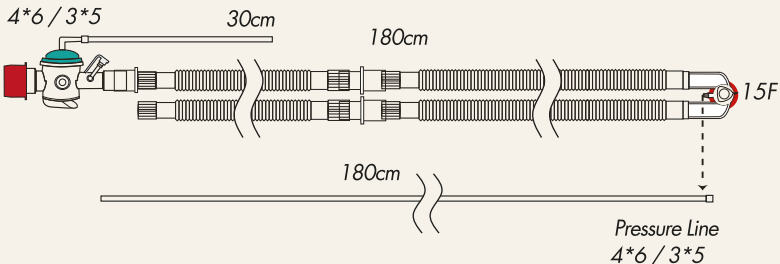

Corrugated

	Length	Code	Qty/Box
Neonatal	300 cm/~118"	75008006-1	30

Exhalation Valve Line

4*6 / 3*5

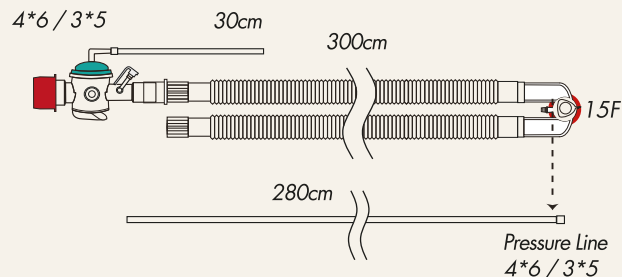

Corrugated

	Length	Code	Qty/Box
Neonatal	180 cm/~71"	75005006-2	30

Exhalation Valve Line

4*6 / 3*5

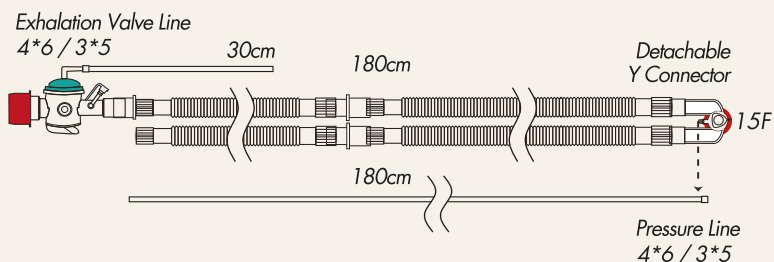

HEATED WIRE CIRCUITS



- Designed for use with heated - wire humidifier
- Heating wire technology for improved air heating and minimization of condensation and contamination
- Spiral wire inside the tubing uniformly heating limbs without cold spots
- Compatible with MR850
- Easy color identification: blue inspiratory limb, white expiratory limb

Single Heated Wire Circuits

Corrugated	Length	Code	Qty/Box
Adult	150 cm/~60"	13113001	25

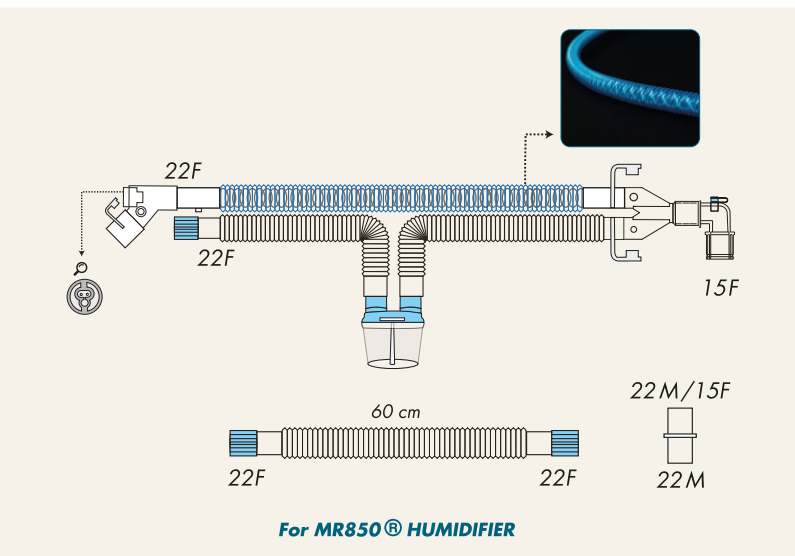

Double Heated Wire Circuits

Corrugated	Length	Code	Qty/Box
Adult	150 cm/~60"	13103002	30

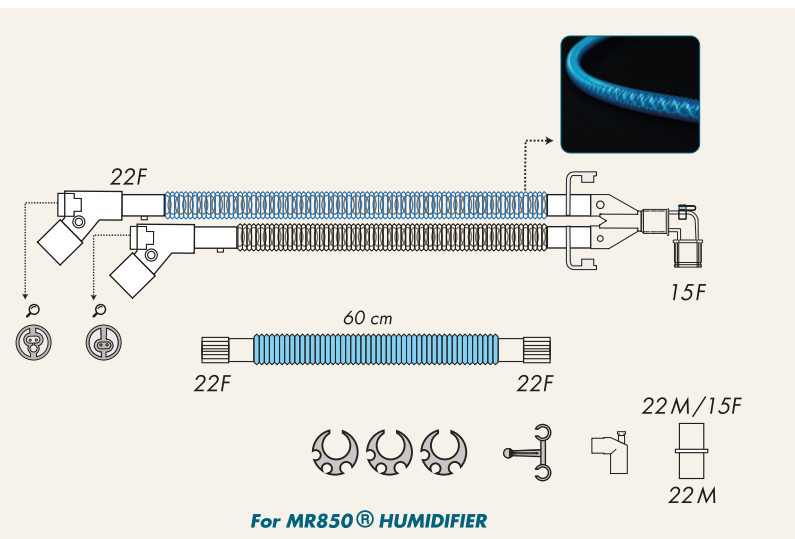

NEONATAL CIRCUITS

- Successful notch design eliminates the risk of disconnection and leakage in the circuits
- All circuit types can be customized
- R-Vent has the capacity of customization which provide end-users with an endless number of disposable breathing circuit configurations
- Easy color identification: blue inspiratory limb, white expiratory limb



Single Heated Wire Universal Circuit

Corrugated

	Length	Code	Qty/Box
Neonatal	150 cm/~60"	75113001	50
Neonatal	150 cm/~60"	75113001-1 (with auto feed chamber)	40

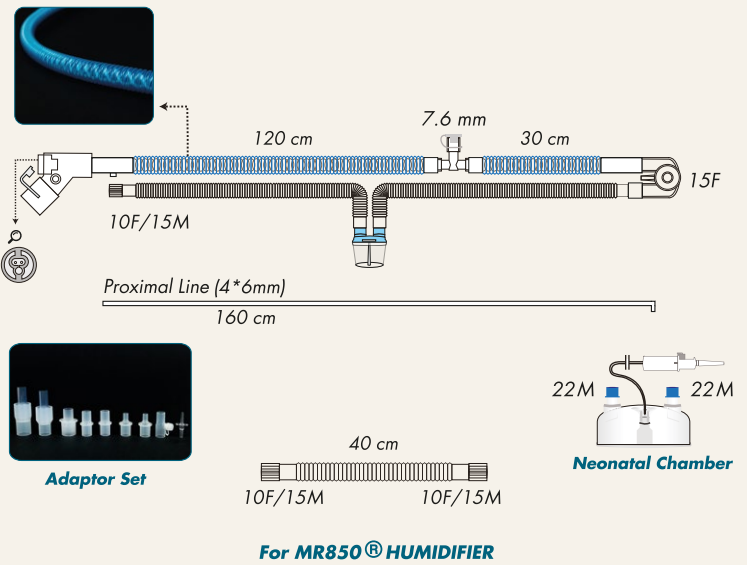

Corrugated

	Length	Code	Qty/Box
Neonatal	150 cm/~60"	75113001-3 (with chamber)	50
Neonatal	150 cm/~60"	75113001-6	50

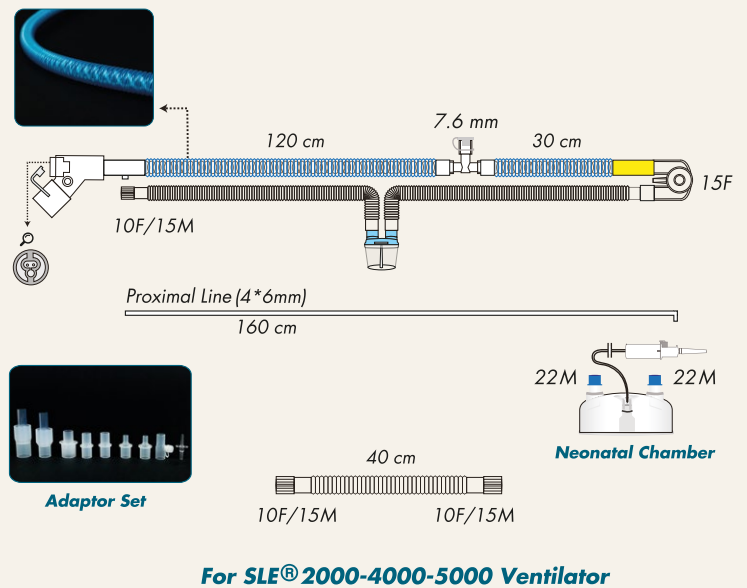

• SLE 2000,4000,5000 are trademarks of SLE Ltd

• Double Heated Wire Universal Circuit

Corrugated

	Length	Code	Qty/Box
Neonatal	150 cm/~60"	75103002	50
Neonatal	150 cm/~60" (with auto feed chamber)	75103002-1	50

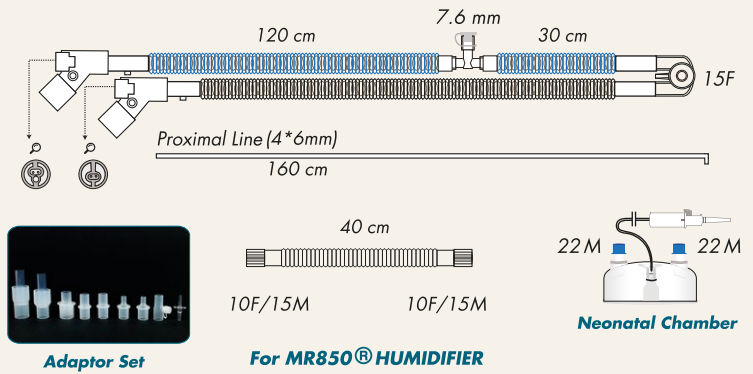

• Medin Medjet® Ventilator Circuit

Corrugated

	Length	Code	Qty/Box
Neonatal	150 cm/~60"	70103009	50

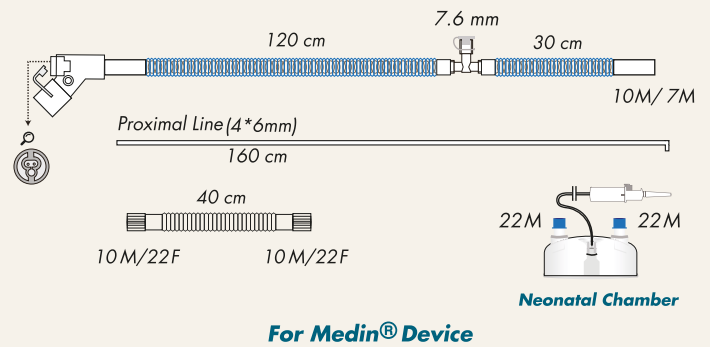

• Medjet is trademark of Medin Medical Innovations

HUMIDIFIER CHAMBER

- Disposable
- Low compliance
- Suitable for F&P heater base
- Suitable to neonatal, infant, pediatric, adult ventilation
- Autofeed water level control decreasing the risk of contamination
- With auto-feed system



Auto-Feed Humidifier Chamber (Adult)

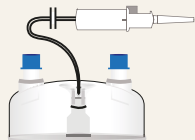

Description	Code	Qty/Box
Auto-feed Humidifier Chamber (Adult)	955	40

- Inlet/Outlet Size: 22 M/ 22 M
- Compressible volume-full: 260 ml
- Maximum water capacity: 180 ml
- Maximum peak flow: 90 l/min
- Resistance to flow: 0.06 cm H₂O @30 LPM
- Compliance: 5 ml/cm H₂O

Auto-Feed Humidifier Chamber (Neonatal)

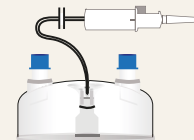

Description	Code	Qty/Box
Auto-feed Humidifier Chamber (Neonatal)	995	40

- Inlet/Outlet Size: 22 M/ 22 M
- Compressible volume-full: 120 ml
- Maximum water capacity: 180 ml
- Maximum peak flow: 90 l/min
- Resistance to flow: 0.74 cm H₂O @2,5 LPM
- Compliance: 1,5 ml/cm H₂O

CPAP CIRCUITS

- Continuous Positive Airway Pressure (CPAP) is the method of ventilating a patient applying higher pressure than environmental atmospheric pressure to the airways of the patient to improve oxygenation via ventilator or CPAP machine.
- CPAP prevents early end-expiratory closure of the airways and alveolar collapse.
- Today CPAP is routinely used for mechanically ventilated patients or spontaneously breathing respiratory patients to improve the oxygenation

CPAP Indications

- Obstructive sleep apnea syndrome, ARDS, Post-operative atelectasis
- Acute respiratory distress, COPD, Cardiogenic pulmonary oedema
- Post-extubation hypoxemia, Weaning

CPAP Circuit For Non-Invasive Ventilation

Corrugated	Length	Code	Qty/Box
Adult	160 cm/~63"	10004069	30

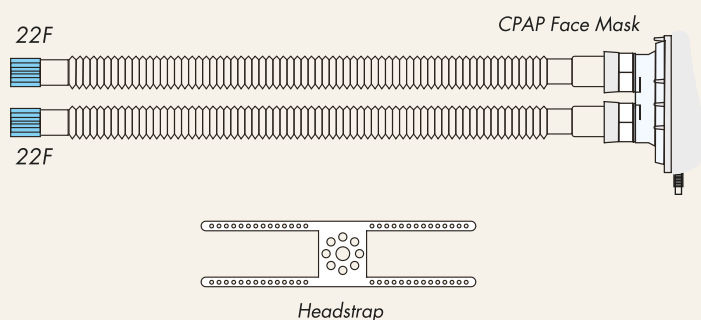

For Non-Invasive Ventilation

CPAP Circuit For Flow Generators

Corrugated	Length	Code	Qty/Box
Adult	160 cm/~63"	10004089	45

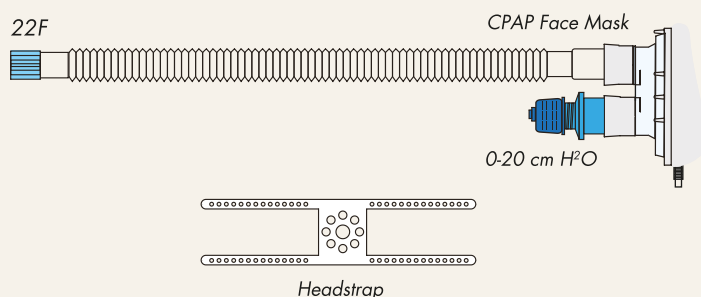

BPAP CIRCUITS

- Bilevel Positive Airway Pressure (BPAP) is a modified version of the continuous positive airway pressure (CPAP).
- It is a mode of ventilation with cycling variations between two continuous positive airway pressure levels. This mode offers two different levels of air pressure: Increased pressure during inhalation and decreased pressure during exhalation.
- In adults this mode of ventilation is effective and is being accepted with a decrease in need for sedatives because of the ability to breathe spontaneously during the entire breathing cycle.
- BPAPs may work better for those individuals who cannot comfortably breathe out against the fixed pressure of the standard device. Therefore BPAP is used for patients with restrictive or obstructive disorders, and for patients with sleep apnea who cannot tolerate the high pressure of CPAP.

BPAP Circuit, Full Face Mask

Corrugated	Length	Code	Qty/Box
Adult	160 cm/~63"	10004079	30

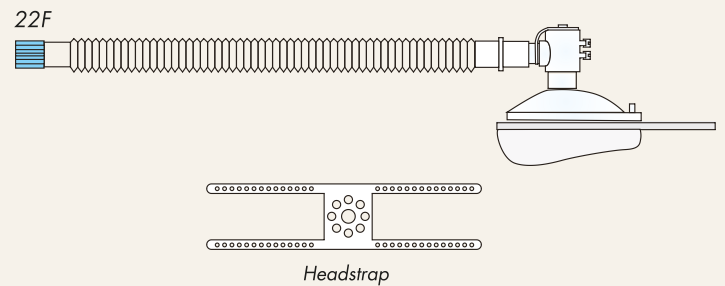

BPAP Circuit, Nasal Mask

Corrugated	Length	Code	Qty/Box
Adult	160 cm/~63"	10004099	30

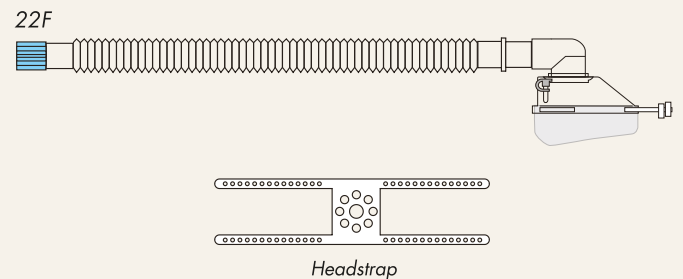

BPAP Circuit

Smooth Bore	Length	Code	Qty/Box
Adult	180 cm/~71"	20005009	50

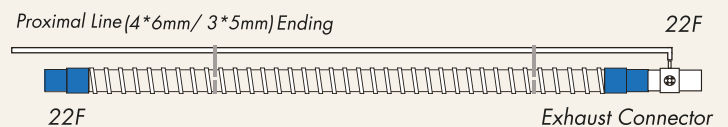

For use with Respironics BiPAP® Vision and S/T-D

- Acute care non invasive ventilation circuit
- Perfect solution for dry high flow gas

CATHETER MOUNT

- R-Vent offers a variety of different catheter mounts for connection of the breathing system or/and filter to the patient.
- The products are CE marked and comply with ISO13485:2016 quality regulation.
- Available as sterile/non sterile in three different tubing types: corrugated, extendable, smoothbore.
- CO₂ aspiration bronchoscopy ported
- Sterile option available



Smooth Bore

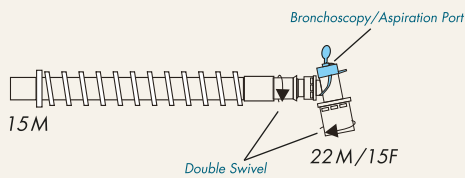

Dead space (ml): 30

Length	Code	Qty/Box
15 cm/~6"	312300	75

Smooth Bore

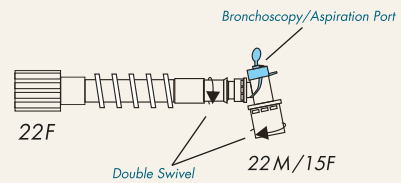

Length	Code	Qty/Box
5 cm/~2"	316100	50

Smooth Bore

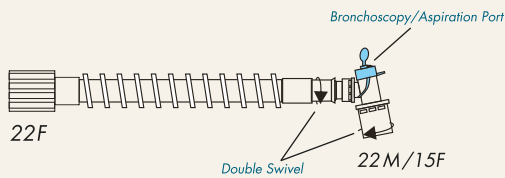

Dead space (ml): 30

Length	Code	Qty/Box
15 cm/~6"	316300	75

Smooth Bore

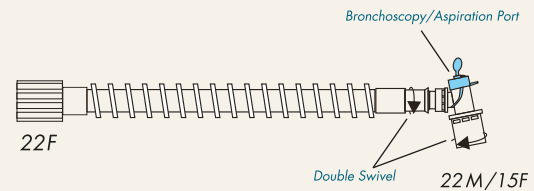

Length	Code	Qty/Box
20 cm/~8"	316400	75

Smooth Bore

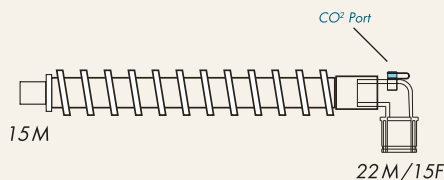

Dead space (ml): 30

Length	Code	Qty/Box
15 cm/~6"	322300	75

Smooth Bore

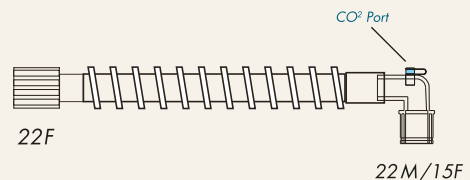

Dead space (ml): 30

Length	Code	Qty/Box
15 cm/~6"	326300	75

Extendible

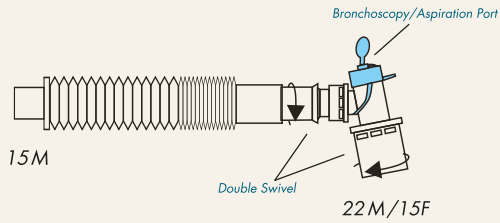

Dead space (ml): Close: 25, Open: 40

Length	Code	Qty/Box
15 cm/~6"	313300	50

Extendible

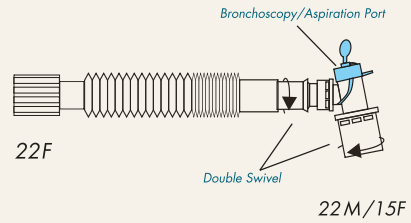

Dead space (ml): Close: 25, Open: 40

Length	Code	Qty/Box
15 cm/~6"	317300	50

Extendible

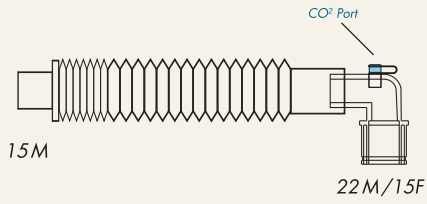

Dead space (ml): Close: 25, Open: 40

Length	Code	Qty/Box
15 cm/~6"	323300	50

Extendible

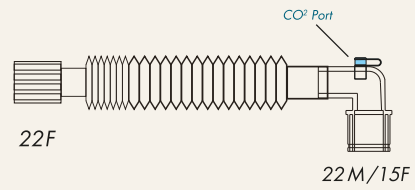

Dead space (ml): Close: 25, Open: 40

Length	Code	Qty/Box
15 cm/~6"	327300	50

Extendible



Dead space (ml): Close: 22, Open: 37

Length	Code	Qty/Box
15 cm/~6"	367300	50

Smooth Bore

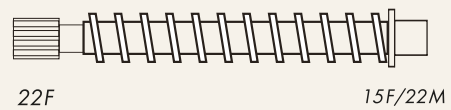

Dead space (ml): 27

Length	Code	Qty/Box
15 cm/~6"	366300	75

Extendible

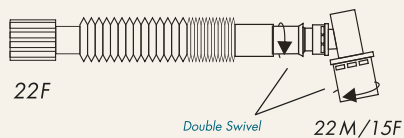

Dead space (ml): Close: 25, Open: 40

Length	Code	Qty/Box
15 cm/~6"	377300	50

Smooth Bore

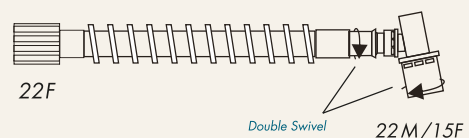

Dead space (ml): 30

Length	Code	Qty/Box
15 cm/~6"	376300	75

Extendible + Filter

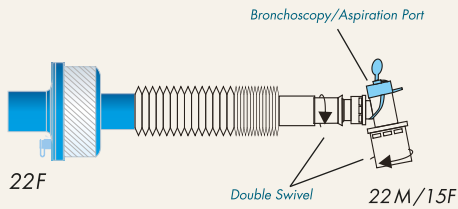

Dead space (ml): Close: 103, Open: 117

Length	Code	Qty/Box
15 cm/~6"	317340	40

Swivel Catheter Mount

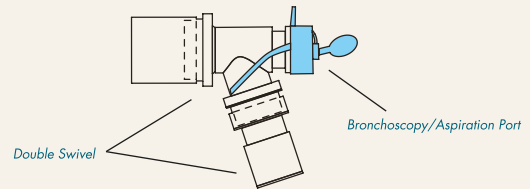

Dead space (ml): 3

Length	Code	Qty/Box
_____	310000	75

Resistance to Flow

Code	30 lt/min	60 lt/min mmH ₂ O	90 lt/min
317340	6	11	14
312300	3	13	21
316300	3	11	30
313300	2	8	22
317300	3	8	19
310000	3	8	19
367300	1	5	7
366300	1	4	7
326300	1	2	8
322300	1	5	10
327300	1	5	16
323300	2	6	16

FILTERS



Bacterial-Viral Filters

- Transparent, easy to see the surface
- High efficiency with low resistance electrostatic filters
- Effective to prevent microbial cross contamination
- Remarkably efficient heat and moisture exchangers
- 15 mm/22 mm connectors conforming to ISO Standards
- Retainable cap
- Inspected and approved by third party experts

Bacterial-Viral Filter 	Code	40920
	Sterile Code	40920S
	Qty./Box	50
	Tidal Volume(ml)	150-1500
	Dead Space(ml)	33
	Bacterial-Viral Efficiency	>99,999%
	Viral Efficiency	>99,99%
	Resistance to Flow	30 lt/min 8 mm H ² O 60 lt/min 17 mm H ² O 90 lt/min 27 mm H ² O
	Weight (gr)	17,2
	Fittings	22F-15M/22M-15F

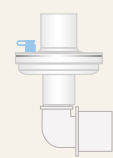
Bacterial-Viral Filter Angled 	Code	40921
	Sterile Code	40921S
	Qty./Box	50
	Tidal Volume(ml)	150-1500
	Dead Space(ml)	36
	Bacterial-Viral Efficiency	>99,999%
	Viral Efficiency	>99,99%
	Resistance to Flow	30 lt/min 8 mm H ² O 60 lt/min 17 mm H ² O 90 lt/min 27 mm H ² O
	Weight (gr)	22,7
	Fittings	22F-15M/22M-15F

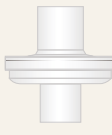
Bacterial-Viral Filter without port 	Code	40900
	Qty./Box	50
	Tidal Volume(ml)	150-1500
	Dead Space(ml)	33
	Bacterial-Viral Efficiency	>99,999%
	Viral Efficiency	>99,99%
	Resistance to Flow	30 lt/min 8 mm H ² O 60 lt/min 17 mm H ² O 90 lt/min 27 mm H ² O
	Weight (gr)	17,2
	Fittings	22F-15M/22M-15F

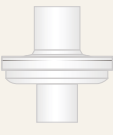
Bacterial-Viral Filter without port sterile 	Code	40900S
	Qty./Box	50
	Tidal Volume(ml)	150-1500
	Dead Space(ml)	33
	Bacterial-Viral Efficiency	>99,999%
	Viral Efficiency	>99,99%
	Resistance to Flow	30 lt/min 8 mm H ² O 60 lt/min 17 mm H ² O 90 lt/min 27 mm H ² O
	Weight (gr)	17,2
	Fittings	22F-15M/22M-15F

Bacterial-Viral HME Filters

- Transparent
- Low dead space
- Gas sampling port available
- Straight and angled choices
- Low resistance
- Latex-free
- Inspected and approved by third party experts

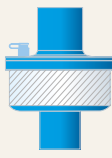
Bacterial-Viral HME Filter with paper HME 	Code	40820
	Sterile Code	40820S
	Qty./Box	45
	Tidal Volume(ml)	150-1500
	Dead Space(ml)	53
	Bacterial-Viral Efficiency	>99,999%
	Viral Efficiency	>99,99%
	Resistance to Flow	30 lt/min 10 mm H ² O 60 lt/min 22 mm H ² O 90 lt/min 36 mm H ² O
	Weight (gr)	26,2
	Fittings	22F-15M/22M-15F
Humidification efficiency	37,3 mg/l H ² O (500 ml tid. vol)	

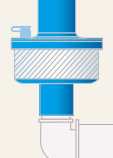
Bacterial-Viral HME Filter Angled with paper HME 	Code	40821
	Sterile Code	40821S
	Qty./Box	45
	Tidal Volume(ml)	150-1500
	Dead Space(ml)	55
	Bacterial-Viral Efficiency	>99,999%
	Viral Efficiency	>99,99%
	Resistance to Flow	30 lt/min 10 mm H ² O 60 lt/min 22 mm H ² O 90 lt/min 36 mm H ² O
	Weight (gr)	31,7
	Fittings	22F-15M/22M-15F
Humidification efficiency	37,3 mg/l H ² O (500 ml tid. vol)	



HEPA Filters (Mechanical Filters)

- Protects patients airways effectively from exogenous microbial loads
- Reduces the risk of extrinsic colonization and infection
- Prevents any cross-contamination between patient and machine
- Indicated for use with patients whose upper airways are being bypassed by an artificial tracheal airway or receiving artificial ventilator support

 <p>Adult HEPA Filter</p>	Code	40320
	Sterile Code	40320S
	Qty/Box	40
	Tidal Volume(ml)	500
	Dead Space(ml)	52
	Filtration Efficiency	BFE 99,9999%; VFE 99,999%
	Resistance to Flow	30 lt/min 156 Pa
		60 lt/min 326 Pa
		90 lt/min 508 Pa
	Weight (gr)	40
Fittings	22F-15M/22M-15F	

 <p>Adult HEPA Filter with HME</p>	Code	41520
	Sterile Code	41520S
	Qty/Box	40
	Tidal Volume(ml)	500
	Dead Space(ml)	46
	Filtration Efficiency	BFE 99,999%; VFE 99,9999%
	Humidification Efficiency	32,2mg/l H ₂ O (500ml. tid. vol.)
	Resistance to Flow	30 lt/min 129 Pa
		60 lt/min 305 Pa
		90 lt/min 542 Pa
Weight (gr)	28,4	
Fittings	22F-15M/22M-15F	

Mini Filters

- Optimal filtration performance
- Flat ergonomic design
- Small and light weight
- Gas sampling port
- Straight and angled version
- Latex free
- Inspected and approved by third party experts

 <p>Bacterial-Viral HME Pediatric Filter with paper HME</p>	Code	40410
	Sterile Code	40410S
	Qty/Box	75
	Tidal Volume(ml)	150-300
	Dead Space(ml)	12
	Filtration Efficiency	BFE 99,999%; VFE 99,9%
	Humidification Efficiency	33 mg/l H ₂ O (250 ml. tid. vol.)
	Resistance to Flow	30 lt/min 13mm H ₂ O
		60 lt/min 33mm H ₂ O
		90 lt/min 55mm H ₂ O
Weight (gr)	13,5	
Fittings	22F-15M/22M-15F	

 <p>Bacterial-Viral HME Pediatric Filter Angled with paper HME</p>	Code	40411
	Sterile Code	40411S
	Qty/Box	75
	Tidal Volume(ml)	150-300
	Dead Space(ml)	12
	Filtration Efficiency	BFE 99,999%; VFE 99,9%
	Humidification Efficiency	33 mg/l H ₂ O (250 ml. tid. vol.)
	Resistance to Flow	30 lt/min 13mm H ₂ O
		60 lt/min 33mm H ₂ O
		90 lt/min 55mm H ₂ O
Weight (gr)	18,5	
Fittings	22F-15M/22M-15F	

 <p>Bacterial-Viral HME Neonatal Filter with paper HME</p>	Code	40210
	Sterile Code	40210S
	Qty/Box	75
	Tidal Volume(ml)	70-150
	Dead Space(ml)	8
	Filtration Efficiency	BFE 99,999%; VFE 99,9%
	Humidification Efficiency	22 mg/l H ₂ O (250 ml. tid. vol.)
	Resistance to Flow	10 lt/min 13mm H ₂ O
		15 lt/min 24mm H ₂ O
		30 lt/min 60mm H ₂ O
Weight (gr)	8	
Fittings	15M-8M/15F	

 <p>Bacterial-Viral HME Neonatal Filter Angled with paper HME</p>	Code	40211
	Sterile Code	40211S
	Qty/Box	75
	Tidal Volume(ml)	70-150
	Dead Space(ml)	8
	Filtration Efficiency	BFE 99,999%; VFE 99,9%
	Humidification Efficiency	22 mg/l H ₂ O (250 ml. tid. vol.)
	Resistance to Flow	10 lt/min 13mm H ₂ O
		15 lt/min 24mm H ₂ O
		30 lt/min 60mm H ₂ O
Weight (gr)	14	
Fittings	15M-8M/15F	

FILTERS

→ R-Vent offers 2 different type of tracheostomy filters for different user preference and usages



Tracheostomy HMEs

→ Extreme low resistance

<p>HME</p>	Code	40100
	Sterile Code	40100S
	Qty/Box	75
	Tidal Volume(ml)	200-1500
	Dead Space(ml)	6
	Humidification Efficiency	25 mg/l H ₂ O (500 ml. tid. vol.)
	Resistance to Flow	30lt/min 5mm H ₂ O
	Weight (gr)	5
	Connections	1.5 F

→ Paper Media

<p>HME with Oxygen Tubing</p>	Code	40200
	Sterile Code	40200S
	Qty/Box	50
	Tidal Volume(ml)	200-1500
	Dead Space(ml)	13
	Humidification Efficiency	25 mg/l H ₂ O (500 ml. tid. vol.)
	Resistance to Flow	30lt/min 5mm H ₂ O
	Weight (gr)	50,5
	Fittings	1.5 F / 5M connector
		5M Oxygen Tubing Connection

→ Central port for suctioning & sampling
→ Extreme low resistance

<p>HME</p>	Code	41100
	Sterile Code	41100S
	Qty/Box	75
	Tidal Volume(ml)	200-1500
	Dead Space(ml)	7
	Humidification Efficiency	30 mg/l H ₂ O (500 ml. tid. vol.)
	Resistance to Flow	30lt/min 3mm H ₂ O 60lt/min 5mm H ₂ O 90lt/min 7mm H ₂ O
	Weight (gr)	9,5
	Connections	1.5 F / 5M connector

→ Recommended use; for patients over 15kg
→ Paper Media

<p>HME with Oxygen Tubing</p>	Code	41200
	Sterile Code	41200S
	Qty/Box	50
	Tidal Volume(ml)	200-1500
	Dead Space(ml)	7
	Humidification Efficiency	30 mg/l H ₂ O (500 ml. tid. vol.)
	Resistance to Flow	30lt/min 3mm H ₂ O 60lt/min 5mm H ₂ O 90lt/min 7mm H ₂ O
	Weight (gr)	55
	Fittings	1.5 F / 5M connector
		5M Oxygen Tubing Connection

GAS SAMPLING LINES

- Prevents waste of anesthetic gases and accurately measures CO₂, O₂, and N₂O levels
- Manufactured to the highest quality standards using medical-grade materials
- Disposable, single patient use
- Non-sterile, latex-free
- 3 layer tubing to prevent diffusion of anesthetic gasses (PE/EVA/PVC)
- M/M and F/M luer options available
- 2/3 meter length options available to arrange distance from anesthesia circuit to the monitor
- For moisture and bacterial contamination protection, gas sampling lines with filters of 0.5µ microns are available

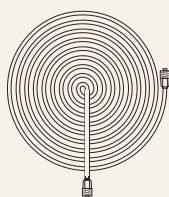

Gas Monitoring Lines

Tubing	Connection	Length	Code	Qty/Box
1,20 mmID X 2,80 mmOD Tubing	male-male connector	3 m /~118"	3114	100
1,20 mmID X 2,80 mmOD Tubing	male-female connector	3 m /~118"	3104	100
1,20 mmID X 2,80 mmOD Tubing	male-male connector	2 m /~79"	2114	100
1,20 mmID X 2,80 mmOD Tubing	male-female connector	2 m /~79"	2104	100

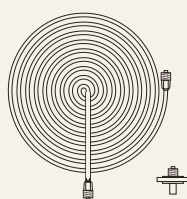

Gas Monitoring Lines + 0,5 micron filter

Tubing	Connection	Length	Code	Qty/Box
1,20 mmID X 2,80 mmOD Tubing	male-male connector	3 m /118"	3114F	100
1,20 mmID X 2,80 mmOD Tubing	male-female connector	3 m /118"	3104F	100

CLOSED SUCTION SYSTEMS

- Minimum risk of hypoxemia and containment of potentially infected secretions
- Facilitation of continuous mechanical ventilation and oxygenation for airway suctioning of critically ill patients on ventilatory support
- Fast size recognition with color-coded rings
- Cost effective, safe and convenient use

24 HOURS CLOSED SUCTION SYSTEM

- Sterile, single packaged
- 100 % latex-free
- Recommended time of use: 24 hours
- Without isolation valve

360 Swivel Adaptor

For connecting to Endotracheal Tube or Tracheostomy Tube

Angled Revolvable Adaptor

For connecting to breathing system, flexible movement of patient

Catheter Protective Sleeve

Transparent, medical grade, thermoplastic polyurethane, soft material

MDI Port

For measured dose inhalation, used for the administration of medicaments, with protection cap

Irrigation Port

Anti-reflux device with safety system preventing retrograde flow and loss of PEEP pressure and contamination

Suction/Flow Control Valve

Free of metallic spring, used to control suction, safety system not allowing retrograde flow and direct contact, color coded

Disconnection Wedge

Used to separate ET/TT from suction catheter

Graduated Suction Catheter

Transparent, medical grade, siliconized PVC for clinical use, latex free and DEHP free, with shape memory, graduated with safety mark to control the depth of aspiration, with atraumatic catheter tip with two side holes

Color	Code	Size	O.D (mm)	I.D (mm)	Length (mm)	Qty/Box
	24050	5 Fr	1,7	1,0	300	80
	24060	6 Fr	2,0	1,1	300	80
	24070	7 Fr	2,3	1,5	300	80
	24080	8 Fr	2,7	1,6	300	80
	24100	10 Fr	3,3	2,1	540	80
	24120	12 Fr	4,0	2,6	540	80
	24140	14 Fr	4,7	3,1	540	80
	24160	16 Fr	5,3	3,6	540	80

72 HOURS CLOSED SUCTION SYSTEM

- Extended use up to 72 hours thanks to isolation valve
- Soft and strong catheter sleeve
- Truly closed system
- No loss of PEEP

- Cost effective
- Wide range of use: Adult & pediatric
- Sterile, single patient use

Color	Code	Size	O.D (mm)	I.D (mm)	Length (mm)	Qty/Box
	72050	5 Fr	1,7	1,0	300	80
	72060	6 Fr	2,0	1,1	300	80
	72070	7 Fr	2,3	1,5	300	80
	72080	8 Fr	2,7	1,6	300	80
	72100	10 Fr	3,3	2,1	540	80
	72120	12 Fr	4,0	2,6	540	80
	72140	14 Fr	4,7	3,1	540	80
	72160	16 Fr	5,3	3,6	540	80

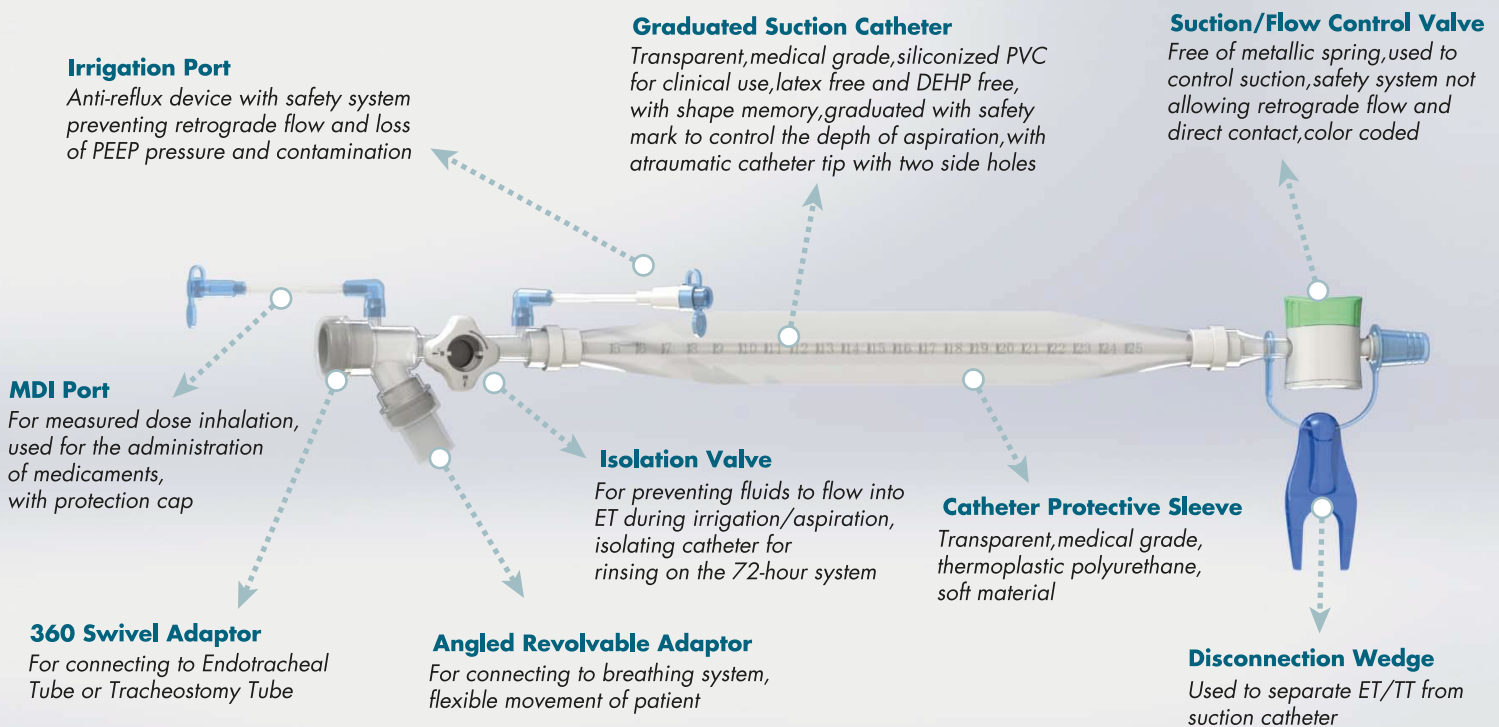

TRACHEOSTOMY CLOSED SUCTION SYSTEM

- Designed for tracheostomy intubated patients
- Atraumatic dual density, 300 mm length catheter for avoiding tracheal irritation
- Depth measurement
- Transparent sleeve
- For extended 72 hours of use
- MDI & Irrigation port available
- Wide range of use: Adult & pediatric

Color	Code	Size	O.D (mm)	I.D (mm)	Length (mm)	Qty/Box
	72101	10 Fr	3,3	2,1	300	80
	72121	12 Fr	4,0	2,6	300	80
	72141	14 Fr	4,7	3,1	300	80
	72161	16 Fr	5,3	3,6	300	80

OXYGEN & AEROSOL THERAPY



- Raw material PVC
- Kink resistant
- Six channel inner lumen design tubing
- Easy rotation with swivel connector on the mask

Flex hose, Nebulizer, Mouth piece, O₂ Tubing

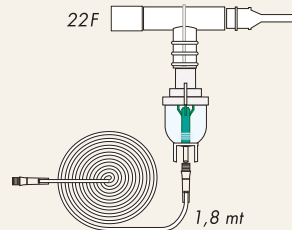

Length	Code	Qty/Box
180 cm/~71"	50120	50

Adult, Nebulizer, Aerosol mask, O₂ Tubing

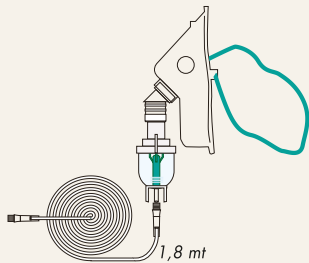

Length	Code	Qty/Box
180 cm/~71"	53210	50

Pediatric, Nebulizer, Aerosol mask, O₂ Tubing

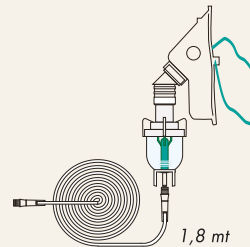

Length	Code	Qty/Box
180 cm/~71"	54210	50

Adult, Oxygen Mask, 1,8 mt O₂ Tubing

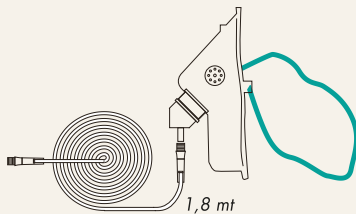

Length	Code	Qty/Box
180 cm/~71"	51200	50

Pediatric, Oxygen Mask, 1,8 mt O₂ Tubing

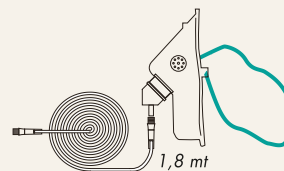

Length	Code	Qty/Box
180 cm/~71"	52200	50

OXYGEN & AEROSOL THERAPY

Adult, High concentration, Rebreathing bag, O₂ Tubing

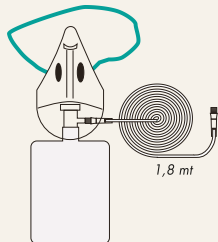

Length	Code	Qty/Box
180 cm/~71"	55200	50

Pediatric, High concentration, Rebreathing bag, O₂ Tubing

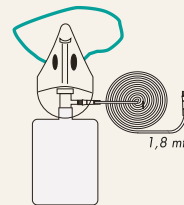

Length	Code	Qty/Box
180 cm/~71"	56200	50

VENTURI SETS

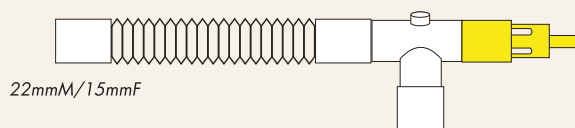

Code	Description	Qty/Box
524	Fixed Venturi Set 24%	50
528	Fixed Venturi Set 28%	50
531	Fixed Venturi Set 31%	50
535	Fixed Venturi Set 35%	50
540	Fixed Venturi Set 40%	50
550	Fixed Venturi Set 50%	50
560	Fixed Venturi Set 60%	50
575	Fixed Venturi Set 75%	50
600	Fixed Venturi Set 100%	50
700	Adjustable Venturi Set 24% to 60%	50



24% jet



28% jet



31% jet



35% jet



40% jet



50% jet



60% jet



75% jet



100% jet



24% to 60% jet

BVM RESUSCITATORS



- Medical grade PVC material
- Disposable
- Latex-free and leakage free
- Single hand operate, elastic material with easy squeezing and well recovery
- Three sizes available - Adult, Pediatric and Infant
- Pressure Pop Off Valve
- Meet ISO Standard

BVM Resuscitator Mask, O₂ Tubing

BVM Resuscitator Large, Mask, O₂ Tubing

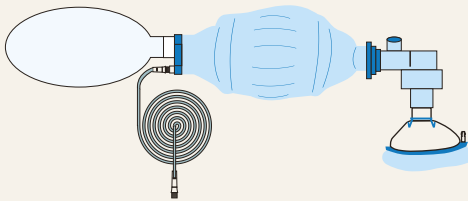

Code	Qty/Box
9000	24

BVM Resuscitator Medium, Mask, O₂ Tubing

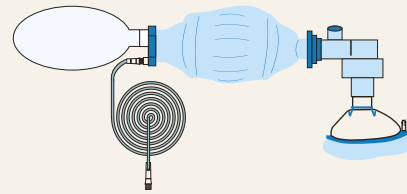

Code	Qty/Box
9010	24

BVM Resuscitator Small, Mask, O₂ Tubing

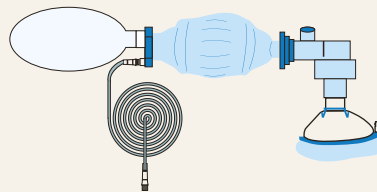

Code	Qty/Box
9020	24

BVM RESUSCITATORS



BVM Resuscitator O₂ Tubing

BVM Resuscitator Large, O₂ Tubing

Code	Qty/Box
9030	24

BVM Resuscitator Mask, O₂ Tubing, Peep Valve

BVM Resuscitator Large, Mask, O₂ Tubing, Peep Valve

Code	Qty/Box
9060	24

BVM Resuscitator Medium, O₂ Tubing

BVM Resuscitator Medium, O₂ Tubing

Code	Qty/Box
9040	24

BVM Resuscitator Medium, Mask, O₂ Tubing, Peep Valve

BVM Resuscitator Medium, Mask, O₂ Tubing, Peep Valve

Code	Qty/Box
9070	24

BVM Resuscitator Small, O₂ Tubing

BVM Resuscitator Small, O₂ Tubing

Code	Qty/Box
9050	24

BVM Resuscitator Small, Mask, O₂ Tubing, Peep Valve

BVM Resuscitator Small, Mask, O₂ Tubing, Peep Valve

Code	Qty/Box
9080	24

BVM RESUSCITATORS



BVM Resuscitator Mask, O₂ Tubing, Manometer

BVM Resuscitator Large, Mask, O₂ Tubing, Manometer

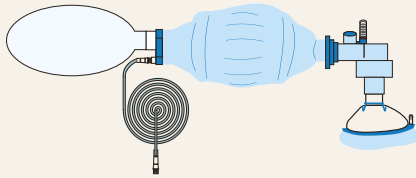

Code	Qty/Box
9031	24

BVM Resuscitator Mask, O₂ Tubing, Manometer, Peep Valve

BVM Resuscitator Large, Mask, O₂ Tubing, Manometer, Peep Valve

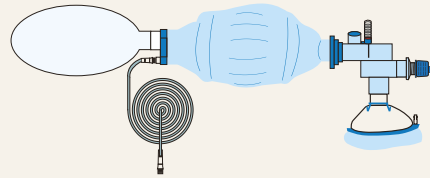

Code	Qty/Box
9061	24

BVM Resuscitator Medium, Mask, O₂ Tubing, Manometer

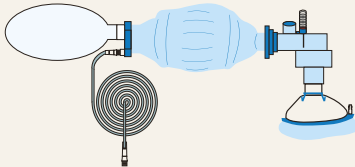

Code	Qty/Box
9041	24

BVM Resuscitator Medium, Mask, O₂ Tubing, Manometer, Peep Valve

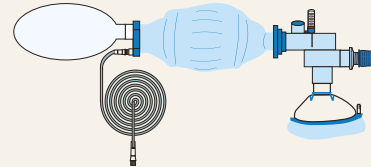

Code	Qty/Box
9071	24

BVM Resuscitator Small, Mask, O₂ Tubing, Manometer

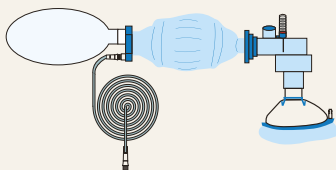

Code	Qty/Box
9051	24

BVM Resuscitator Small, Mask, O₂ Tubing, Manometer, Peep Valve

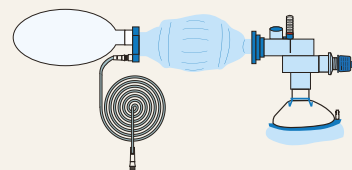

Code	Qty/Box
9081	24

MASKS

ANESTHESIA MASKS

- Designed for anesthesia, respiratory or resuscitation
- Leak-proof, soft and comfortable seal cushion in facial contoured design
- Color coded hook ring for easy size identification
- Single patient use to prevent cross contamination
- Light weight for patient comfort
- Standard and scented types
- Latex-free
- Available in different sizes
- Meets ISO Standards
- Transparent to allow easy observation
- Ideal for single patient use to reduce risk of cross infection

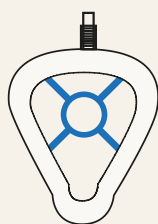

Economy Masks

	Code	Size	Weight	Dead Space	Qty/Box
Respiratory, anesthesia mask #5	8050	Large	49,4 gr	255 ml	100
Respiratory, anesthesia mask #4	8040	Medium	38,6 gr	200 ml	100
Respiratory, anesthesia mask #3	8030	Small	28,9 gr	140 ml	100
Respiratory, anesthesia mask #2	8020	Child	23,6 gr	92 ml	100
Respiratory, anesthesia mask #1	8010	Infant	13,3 gr	51 ml	100
Respiratory, anesthesia mask #0	8000	Neo-nate	9,8 gr	28 ml	100



PVC-FREE ANESTHESIA MASKS

- Non PVC
- Lower impact on patient and environment
- Lighter, better aging, not requiring problematic chemicals, easily recycled
- Transparent cover providing excellent visibility
- Soft air cushion assuring comfortable face fitting
- Available in different sizes

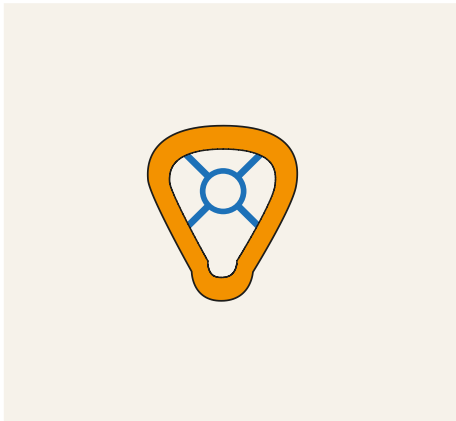

	Code	Size	Qty/Box
Respiratory, anesthesia mask #6	8160	Large	100
Respiratory, anesthesia mask #5	8150	Medium	100
Respiratory, anesthesia mask #4	8140	Small	100
Respiratory, anesthesia mask #3	8130	Pediatric	100
Respiratory, anesthesia mask #2	8120	Infant	100
Respiratory, anesthesia mask #1	8110	Neo-nate	100

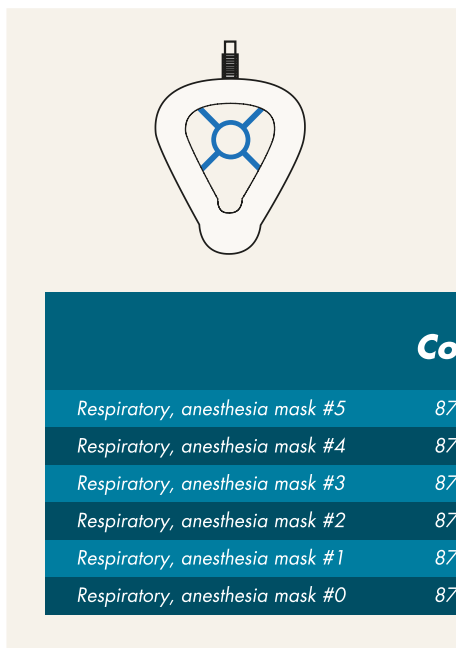

Rotational & Scented Masks

- Flexible, can be adjusted by hand
- Vanilla scented

	Code	Size	Weight	Dead Space	Qty/Box
Respiratory, anesthesia mask #5	8750	Large	51,0 gr	250 ml	100
Respiratory, anesthesia mask #4	8740	Medium	40,6 gr	150 ml	100
Respiratory, anesthesia mask #3	8730	Small	31,2 gr	100 ml	100
Respiratory, anesthesia mask #2	8720	Child	16,7 gr	40 ml	100
Respiratory, anesthesia mask #1	8710	Infant	13,8 gr	25 ml	100
Respiratory, anesthesia mask #0	8700	Neo-nate	13,1 gr	15 ml	100



CPAP Masks



	Code	Size	Weight	Dead Space	Qty/Box
CPAP Air Cushion Face Mask	8400	Adult-Large	56 gr	215 ml	25
CPAP Air Cushion Face Mask	8420	Adult-Small	40 gr	125 ml	30



Full Face Masks

	Code	Size	Weight	Dead Space	Qty/Box
Full Face Mask	8600	Large	174,7 gr	360 ml	20
Full Face Mask	8610	Medium	164,7 gr	330 ml	20
Full Face Mask	8620	Small	158,7 gr	270 ml	20



Nasal Masks

	Code	Size	Dead Space	Qty/Box
Nasal Mask	8310	Medium	85 ml	20

MDI Chamber

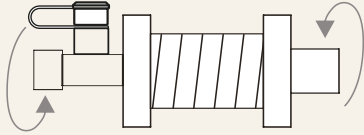

R-Vent MDI Chamber is a single patient use collapsible holding chamber (CHC) used to administer metered dose inhaler medications into a ventilator circuit. It is designed to be left in the inspiratory limb of a ventilator circuit, and can be collapsed when not in use without interruption of continuous mechanical ventilation while keeping the patient less disrupted and less risky for infections. The device is easy to connect and provides efficient aerosol drug delivery. The versatile device can be used with all MDIs including those with integrated dose counters.

Code	Qty/Box
925	50

Silicone Headstrap

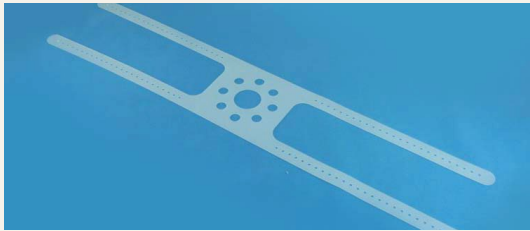

Code	Qty/Box
965	50

Adjustable Peep Valve



Code	Qty/Box
975	50

Latex Breathing Bags



Liter	Code	Qty/Box
3,0	6030	40
2,0	6020	40
1,0	6010	50
0,5	6005	50

Non-Latex (Neoprene) Breathing Bags



Liter	Code	Qty/Box
3,0	6130	40
2,0	6120	40
1,0	6110	50
0,5	6105	50

WATERTRAPS AND PARTS

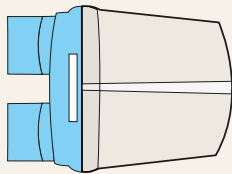

22 mm Water Trap (PP)

Code	Qty/Box
100.11.001	300

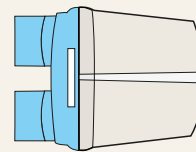

19 mm Water Trap (ABS)

Code	Qty/Box
100.11.007	300

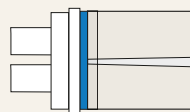

10 mm Water Trap (PP)

Code	Qty/Box
100.13.002	300

Y & T & ELBOW

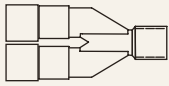

22 mm Parallel Y Connector (PP)

Code	Qty/Box
100.01.004.02	1000

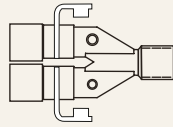

22 mm Parallel Y Connector with 2 Ports with CAPS (PP)

Code	Qty/Box
100.11.004	1000

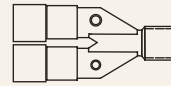

22 mm Parallel Y Connector with 2 Ports (PP)

Code	Qty/Box
100.01.004.01	1000

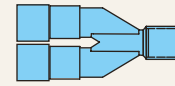

19 mm Parallel Y Connector (ABS)

Code	Qty/Box
100.01.028.02	1000

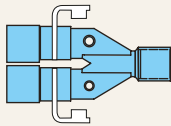

19 mm Parallel Y Connector with 2 Ports with CAPS (ABS)

Code	Qty/Box
100.11.028	1000

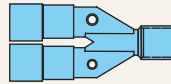

19 mm Parallel Y Connector with 2 Ports (ABS)

Code	Qty/Box
100.01.028.01	1000

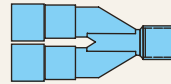

15 mm Parallel Y Connector (ABS)

Code	Qty/Box
100.01.027.04	1200

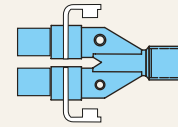

15 mm Parallel Y Connector with 2 Ports with CAPS (ABS)

Code	Qty/Box
100.11.027.01	1200

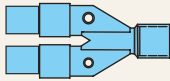

15 mm Parallel Y Connector with 2 Ports (ABS)

Code	Qty/Box
100.01.027.03	1200



Neonatal Y Connector
with temp. connector & proximal pressure line connector (PP)

Code	Qty/Box
100.01.039	2500

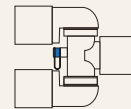

22 mm SWIVEL Y Connector with PORT (PP)

Code	Qty/Box
100.13.005	2500

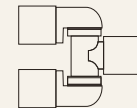

22 mm SWIVEL Y Connector without PORT (PP)

Code	Qty/Box
100.13.006	2500

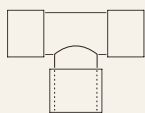

22M-22M-22M T Connector (SBC)

Code	Qty/Box
100.01.053	1200

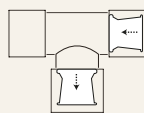

22M-22M-22M T Connector with 2 way valve

Code	Qty/Box
100.11.053	1200

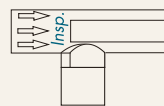

Coaxial Connector Device Side

Code	Qty/Box
100.01.005	1200

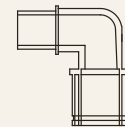

Elbow Connector (PP)

Code	Qty/Box
100.01.006.02	4000

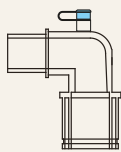

Elbow Connector with CO₂ PORT with Tethered CAP (PP)

Code	Qty/Box
100.11.006	4000

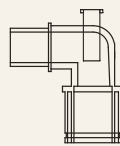

Elbow Connector with CO₂ PORT (PP)

Code	Qty/Box
100.01.006.01	4000

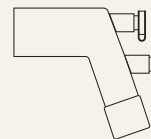

Humidifier Elbow Connector (PP)

Code	Qty/Box
100.13.136	2000

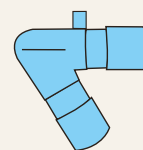

Bag Connector (ABS)

Code	Qty/Box
100.01.029	10000

STRAIGHT

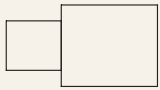

**15M-22F
Straight Connector (SBC)**

Code	Qty/Box
100.01.007	4000

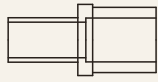

**15M-22M/15F
Straight Connector (PP)**

Code	Qty/Box
100.01.008.02	4000

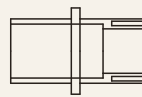

**22M-22M/15F
Straight Connector (PP)**

Code	Qty/Box
100.01.009	4000

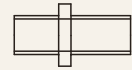

**15M-15M
Straight Connector (PP)**

Code	Qty/Box
100.01.008.01	2500



**22M-22F
Straight Connector (EVA)**

Code	Qty/Box
100.01.010.01	3000

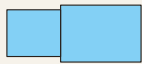

**22M-22F
Straight Connector Blue (EVA)**

Code	Qty/Box
100.01.044	3000



**22M-22F Straight
Connector (PVC)**

Code	Qty/Box
100.01.026	3000



**15M-22F
Connector (PVC)**

Code	Qty/Box
100.13.012	3000

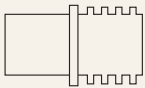

ADU Connector (PP)

Code	Qty/Box
100.13.013	3000

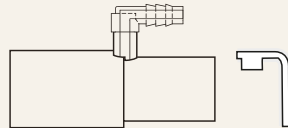

**22M-22F Straight Connector
with Temperature Port,
with Elbow and Cap (PP)**

Code	Qty/Box
100.11.046	2400

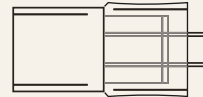

**22F-10M/7F
Straight Connector (PVC)**

Code	Qty/Box
100.13.061	2400

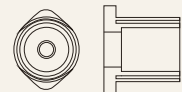

**Swivel Catheter Mount
22 MM Connector (SBC)**

Code	Qty/Box
100.01.011	2400



**Swivel Catheter Mount
15 MM Connector (SBC)**

Code	Qty/Box
100.01.012	2400

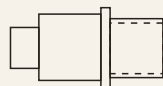

**Coaxial Connector
Patient Side (PP)**

Code	Qty/Box
100.01.013	2400



**22-15F/6M
Straight Connector (PP)**

Code	Qty/Box
100.13.147	10000

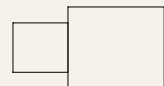

**15M-22F
Straight Connector (EVA)**

Code	Qty/Box
100.01.031.01	4000

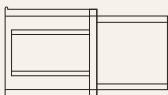

**10M-10F/15M Straight
Neonatal Connector (SBC)**

Code	Qty/Box
100.01.038	2400

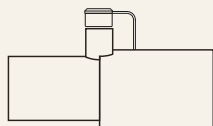

**22M-22F Straight Connector
with Temperature Port,
without Elbow, with Cap (PP)**

Code	Qty/Box
100.11.046-1	2400

OTHERS

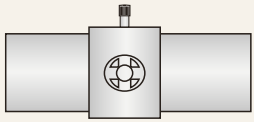

CO₂ Exhalation Connector (PC)

Code	Qty/Box
100.13.019	2400

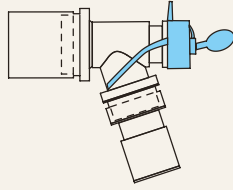

Swivel Catheter Mount with Bronchoscopy/Aspiration Port and Cap

Code	Qty/Box
310000	8000

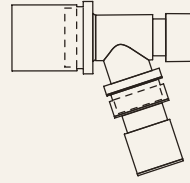

Swivel Catheter Mount without Bronchoscopy/Aspiration Port

Code	Qty/Box
370000	8000

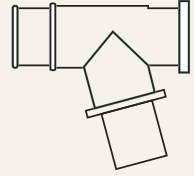

Swivel Catheter Mount Body (PE)

Code	Qty/Box
100.01.014	8000

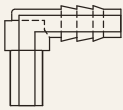

Elbow Connector 7.6MM (PP)

Code	Qty/Box
100.01.016	8000



IPPB Connector without Port

Code	Qty/Box
100.13.021	600



IPPB Connector with Port

Code	Qty/Box
100.11.050	400



Long Connector Cap Red (PE)

Code	Qty/Box
100.01.017	10000



Tube Clip with One Holder (PE)

Code	Qty/Box
100.13.023	12000

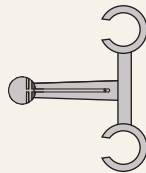

Tube Clip with Two Holder (PE)

Code	Qty/Box
100.13.024	1600

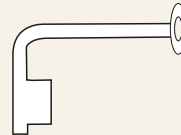

Y Connector CAP (EVA)

Code	Qty/Box
100.01.018	20000



Elbow Connector CAP (PE)

Code	Qty/Box
100.01.019	20000



Long Connector Cap Red Neonatal

Code	Qty/Box
100.13.073	1000

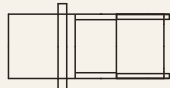

Whisper Swivel Connector

Code	Qty/Box
100.11.054	2400

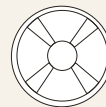

One Way Valve

Code	Qty/Box
100.01.054	1000

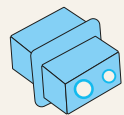

Oxylog® Block Connector

Code	Qty/Box
100.01.030	1000

TUBINGS

CORRUGATED TUBINGS

- Raw material PE
- Available in all colours
- Corrugated inside
- 3 different sizes; 22 mm, 15 mm, 10 mm
- Light weight minimizing pressure on patient
- Flexible, elastic within the tube, resisting crushing



22 mm Corrugated Tubing 50 mt/roll (PE)

100.02.01.001	20 CM/~8"	CUFF
100.02.01.002	30 CM/~12"	CUFF
100.02.01.003	60 CM/~24"	CUFF
100.02.01.004	80 CM/~32"	CUFF
100.02.01.005	90 CM/~36"	CUFF
100.02.01.006	100 CM/~40"	CUFF
100.02.01.007	160 CM/~63"	CUFF

22 mm Corrugated Tubing Cut (PE)

100.02.01.051	60 CM/~24"	CUT
100.02.01.052	80 CM/~32"	CUT
100.02.01.053	90 CM/~36"	CUT
100.02.01.054	100 CM/~40"	CUT
100.02.01.055	160 CM/~63"	CUT

15 mm Corrugated Tubing 50 mt/roll (PE)

100.02.01.101	20 CM/~8"	CUFF
100.02.01.102	30 CM/~12"	CUFF
100.02.01.103	60 CM/~24"	CUFF
100.02.01.104	80 CM/~32"	CUFF
100.02.01.105	90 CM/~36"	CUFF
100.02.01.106	100 CM/~40"	CUFF
100.02.01.107	160 CM/~63"	CUFF

15 mm Corrugated Tubing Cut (PE)

100.02.01.151	60 CM/~24"	CUT
100.02.01.152	80 CM/~32"	CUT
100.02.01.153	90 CM/~36"	CUT
100.02.01.154	100 CM/~40"	CUT
100.02.01.155	160 CM/~63"	CUT

10 mm Corrugated Tubing 50 mt/roll (PE)

100.02.01.201	20 CM/~8"	CUFF
100.02.01.202	30 CM/~12"	CUFF
100.02.01.203	60 CM/~24"	CUFF
100.02.01.204	80 CM/~32"	CUFF
100.02.01.205	90 CM/~36"	CUFF
100.02.01.206	100 CM/~40"	CUFF
100.02.01.207	160 CM/~63"	CUFF

10 mm Corrugated Tubing Cut (PE)

100.02.01.251	60 CM/~24"	CUT
100.02.01.252	80 CM/~32"	CUT
100.02.01.253	90 CM/~36"	CUT
100.02.01.254	100 CM/~40"	CUT
100.02.01.255	160 CM/~63"	CUT



EXTENDIBLE TUBINGS

- Light weight
- 2 different sizes 15 mm and 22 mm
- Corrugated and expandable
- Adjustable shape
- Raw material PP
- Available in all colours
- Resistance to kinking
- Effective storage and disposal



22 mm Extendible Tubing Cut (PP)

100.02.03.001	75 CM/~30"	CUT
100.02.03.002	90 CM/~36"	CUT
100.02.03.003	150 CM/~59"	CUT
100.02.03.004	180 CM/~71"	CUT

15 mm Extendible Tubing Cut (PP)

100.02.03.051	15 CM/~6"	CUT
100.02.03.052	75 CM/~30"	CUT
100.02.03.053	90 CM/~36"	CUT
100.02.03.054	150 CM/~59"	CUT
100.02.03.055	180 CM/~71"	CUT

SMOOTHBORE TUBINGS

- Smooth inside
- 2 different sizes 15mm and 19mm
- Raw material PVC
- Available in all colours
- Low flow resistance
- No water accumulation
- Reduced turbulence
- Low compliance
- Resistant to kinking,
spiral outer casing designed to support patency of airway,
ensuring delivery of fresh gas



19 mm Smoothbore Tubing with Connector (PVC)

100.22.02.001	30 CM/~12"	CUT
100.22.02.002	60 CM/~24"	CUT
100.22.02.003	80 CM/~32"	CUT
100.22.02.004	90 CM/~36"	CUT
100.22.02.005	100 CM/~40"	CUT
100.22.02.006	150 CM/~59"	CUT
100.22.02.007	180 CM/~71"	CUT

15 mm Smoothbore Tubing with Connector (PVC)

100.22.02.051	75 CM/~30"	CUT
100.22.02.052	100 CM/~40"	CUT
100.22.02.053	150 CM/~59"	CUT

PVC-FREE (METALLOCENE) SMOOTHBORE TUBINGS

- Crush-proof, less risk of interruption during ventilation
- Less condensation build-up, less bacterial growth
- Light in weight
- Transparent
- Non-kinking
- Friendly with environment and your health
- Better compliance
- Easily recycled

22 mm Smoothbore Tubing Cut (PVC-Free)

100.02.04.001	30 CM/~12"	CUT
100.02.04.002	40 CM/~16"	CUT
100.02.04.003	45 CM/~18"	CUT
100.02.04.004	55 CM/~22"	CUT
100.02.04.005	75 CM/~30"	CUT
100.02.04.006	85 CM/~34"	CUT
100.02.04.007	95 CM/~38"	CUT
100.02.04.008	115 CM/~45"	CUT
100.02.04.009	145 CM/~57"	CUT
100.02.04.010	155 CM/~61"	CUT
100.02.04.011	175 CM/~69"	CUT
100.02.04.012	195 CM/~77"	CUT
100.02.04.013	225 CM/~88"	CUT
100.02.04.014	245 CM/~96"	CUT
100.02.04.015	295 CM/~116"	CUT
100.02.04.016	360 CM/~142"	CUT

15 mm Smoothbore Tubing Cut (PVC-Free)

100.02.04.051	10 CM/~4"	CUT
100.02.04.052	15 CM/~6"	CUT
100.02.04.053	20 CM/~8"	CUT
100.02.04.054	55 CM/~22"	CUT
100.02.04.055	75 CM/~30"	CUT
100.02.04.056	85 CM/~34"	CUT
100.02.04.057	115 CM/~45"	CUT
100.02.04.058	145 CM/~57"	CUT
100.02.04.059	175 CM/~69"	CUT
100.02.04.060	210 CM/~83"	CUT
100.02.04.061	245 CM/~96"	CUT

10 mm Smoothbore Tubing Cut (PVC-Free)

100.02.04.101	5 CM/~2"	CUT
100.02.04.102	10 CM/~4"	CUT
100.02.04.103	15 CM/~6"	CUT
100.02.04.104	55 CM/~22"	CUT
100.02.04.105	75 CM/~30"	CUT
100.02.04.106	145 CM/~57"	CUT
100.02.04.107	155 CM/~61"	CUT

TAKE A NEW BREATH WITH RVENT

RVENT

Distributed By

R Vent Medikal Üretim A.Ş.

Adress : 29 Ekim Mah. Balkan Cad. No:33,
Yazibasi Beldesi Torbali, 35860 Izmir, Turkey

Tel : +90 232 853 9500

Fax : +90 232 853 9495

Web : www.rventmedikal.com

E-mail : info@rventmedikal.com

RVENT

